

BOW20

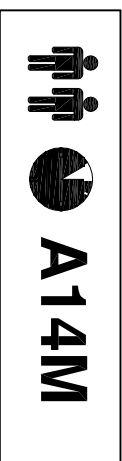

A

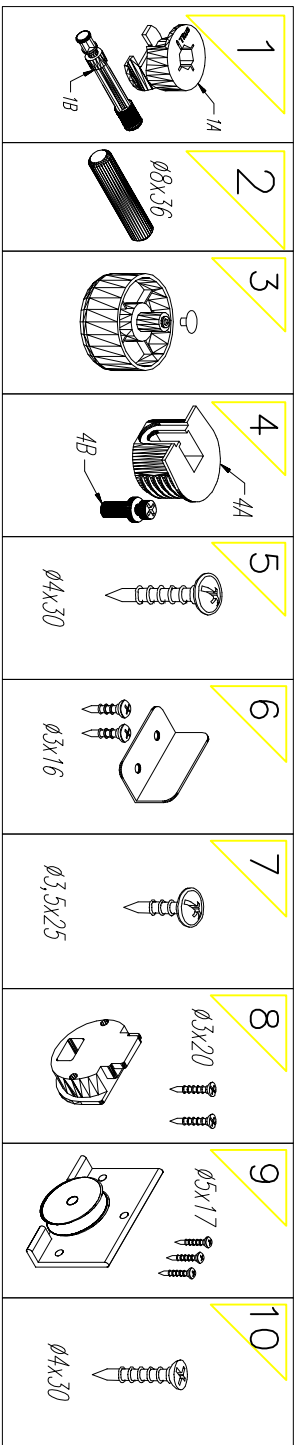
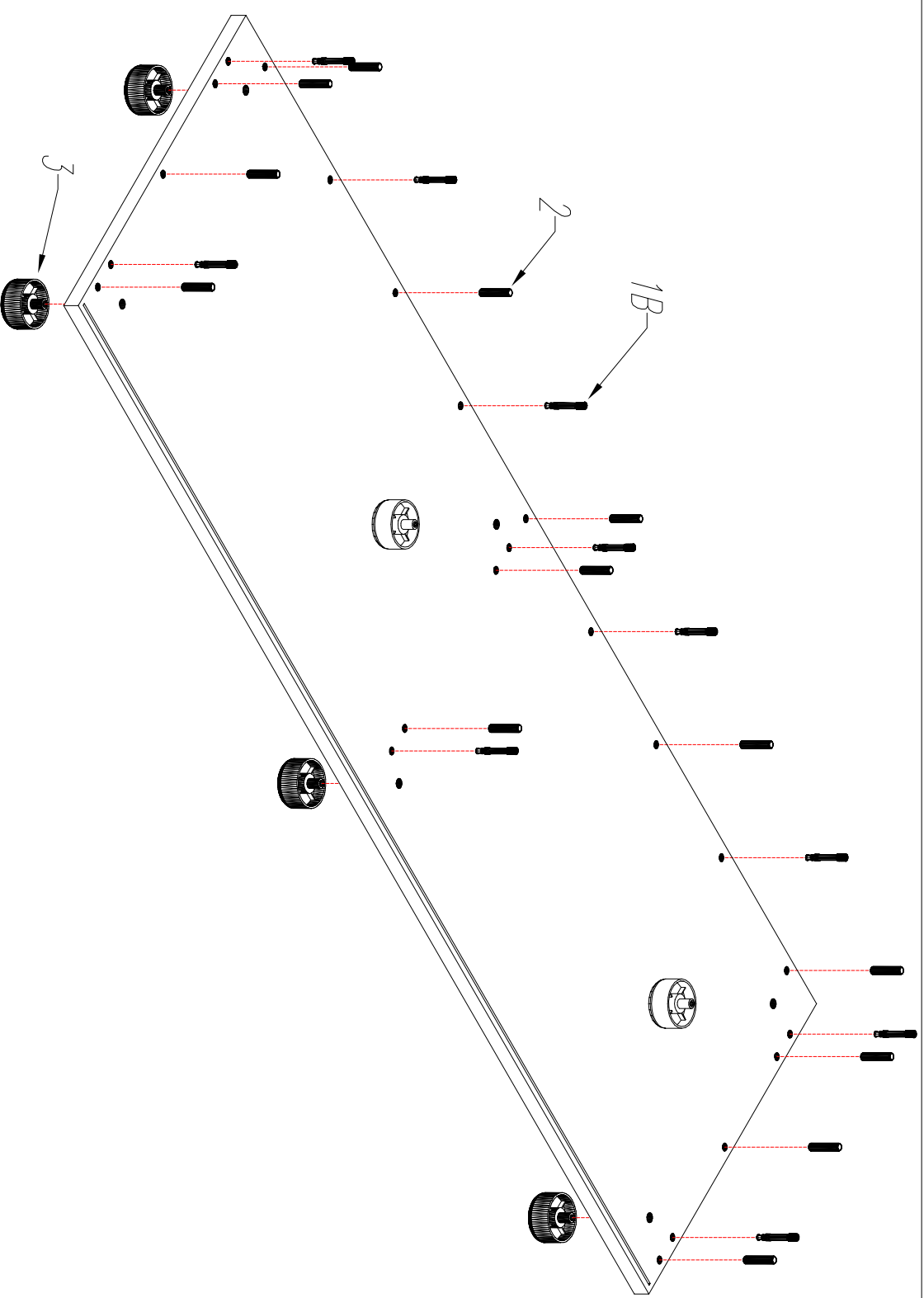

KOLENIŃCZĄ MONTAŻU
 ИМОСТРОИТЬ I КОЛКОВ.
 THE FITTINGS SEQUENCE OF THE
 CAMS AND DOWELS.
 DIE MONTAGEFOLGE VON
 EXZENTERN UND DIBBELN.

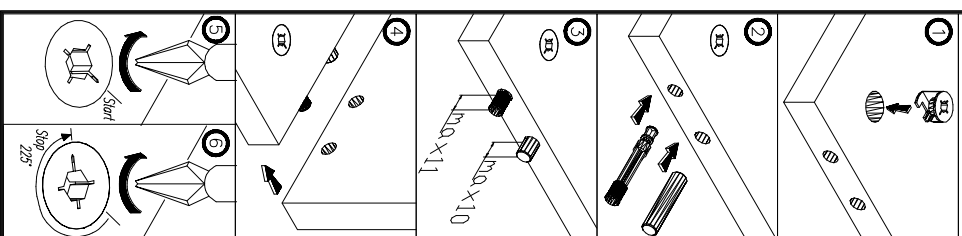

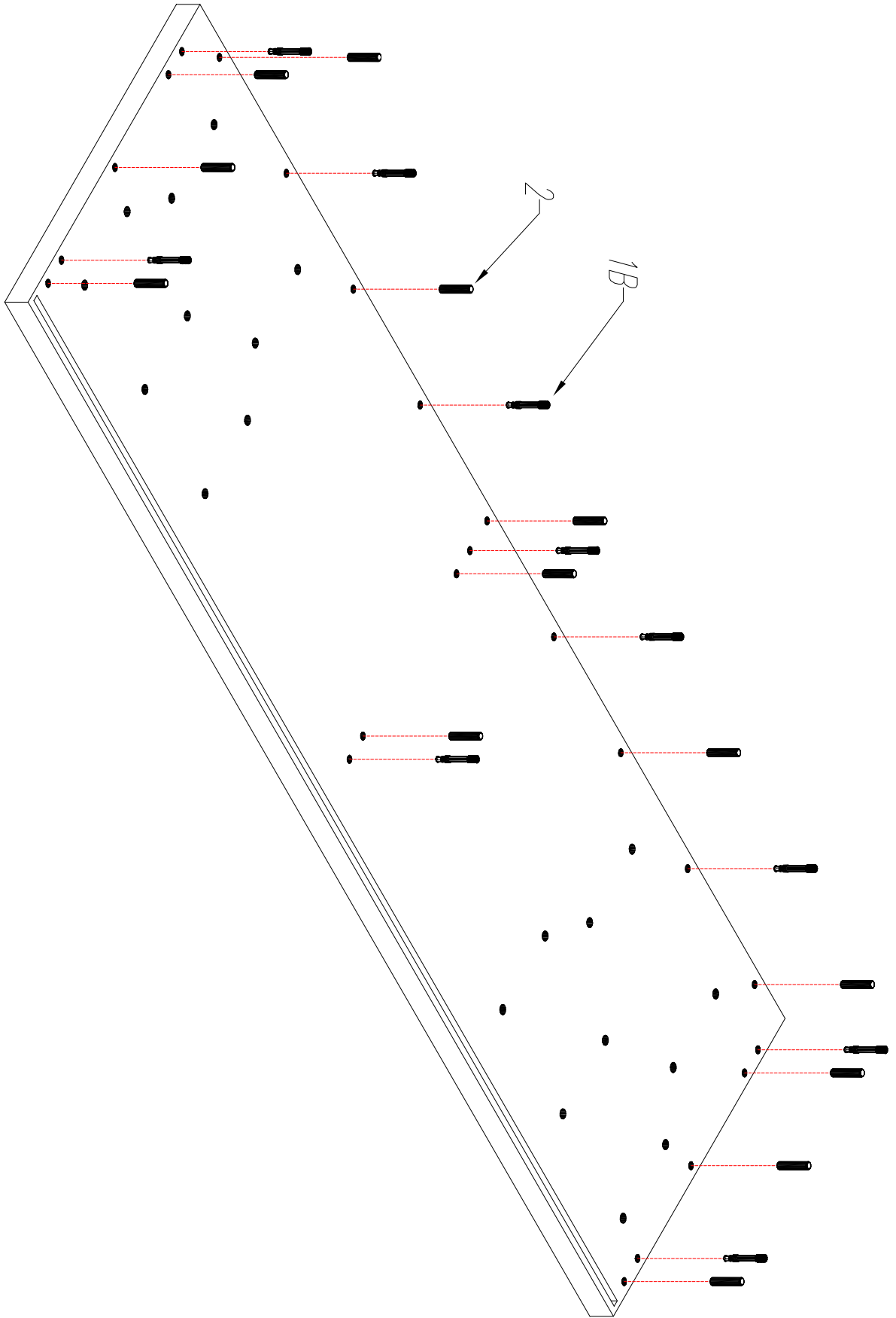

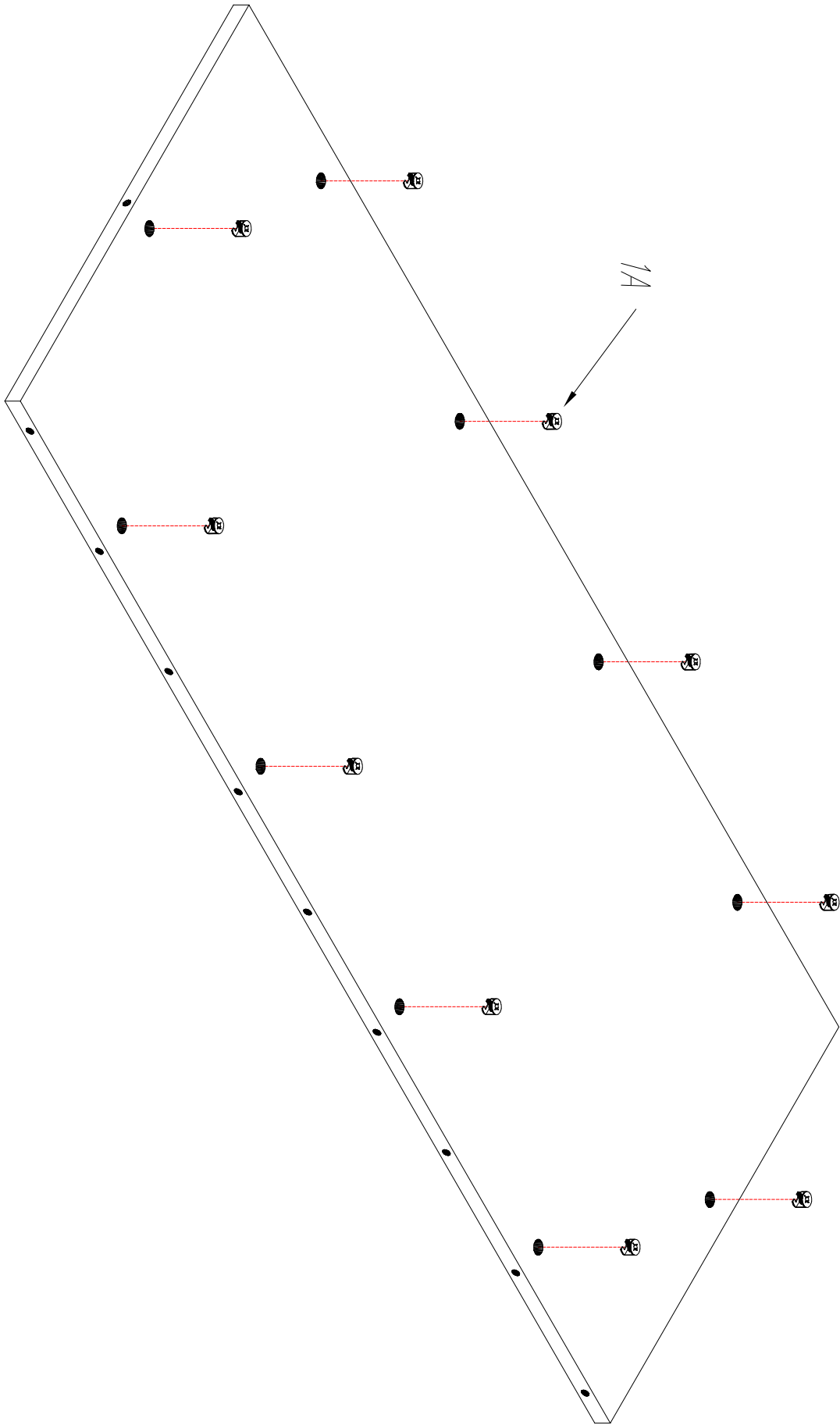

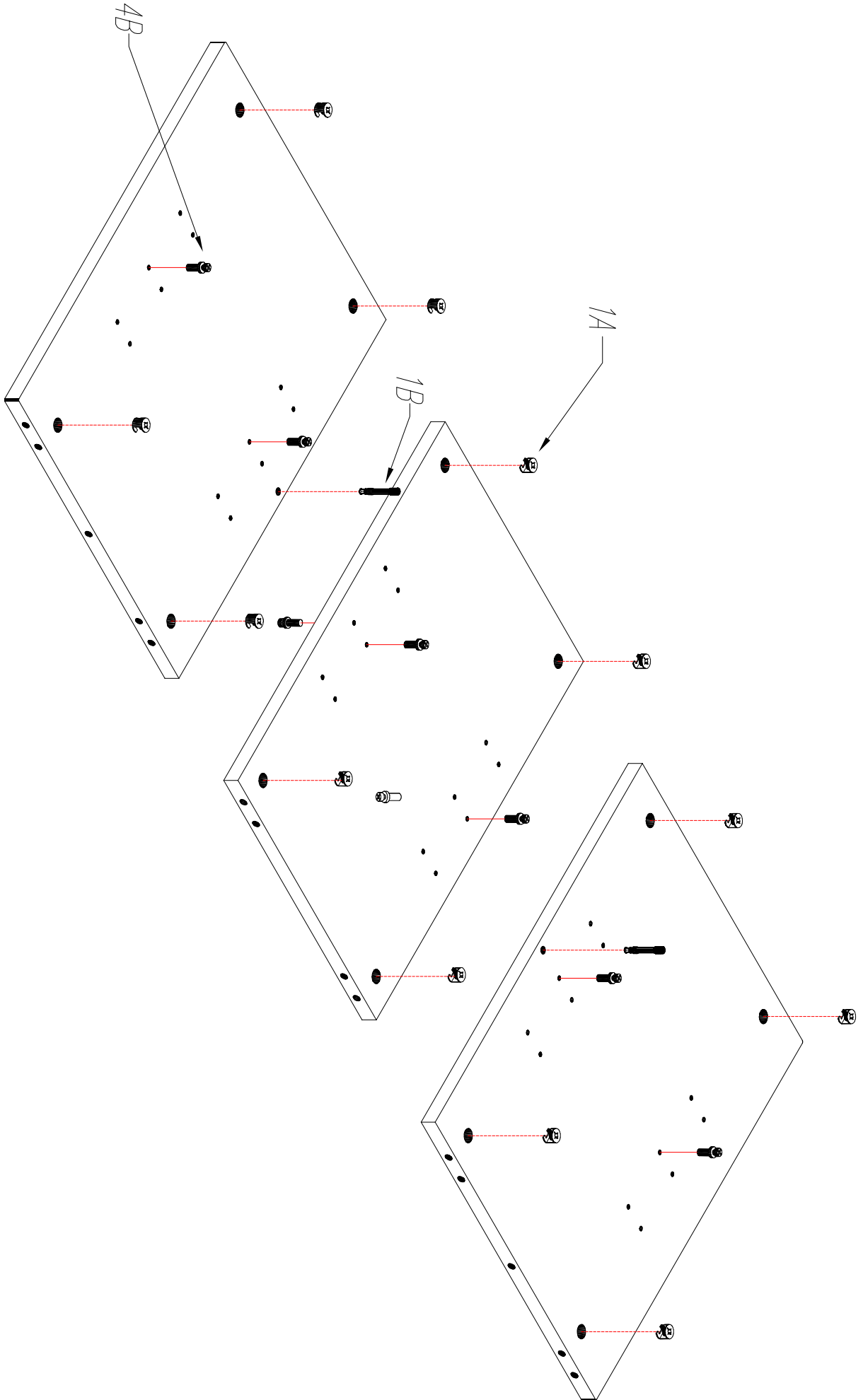

G

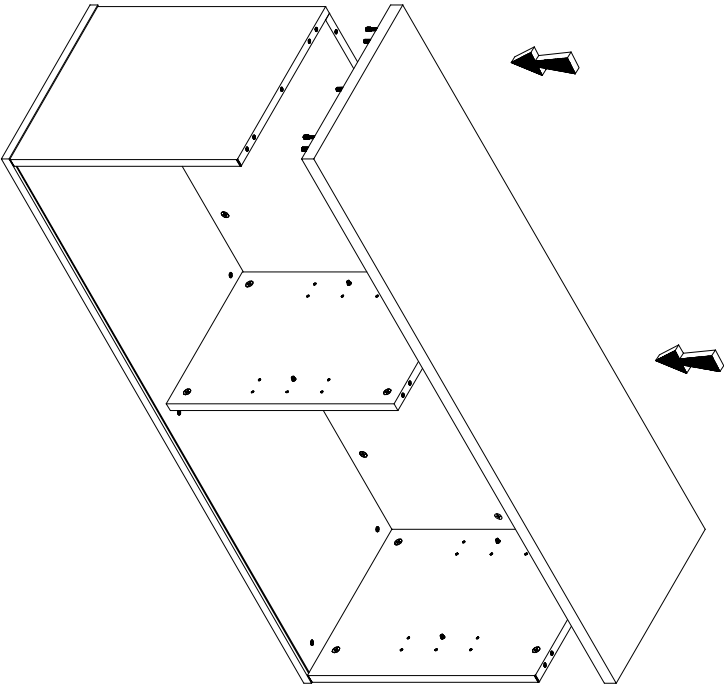

F

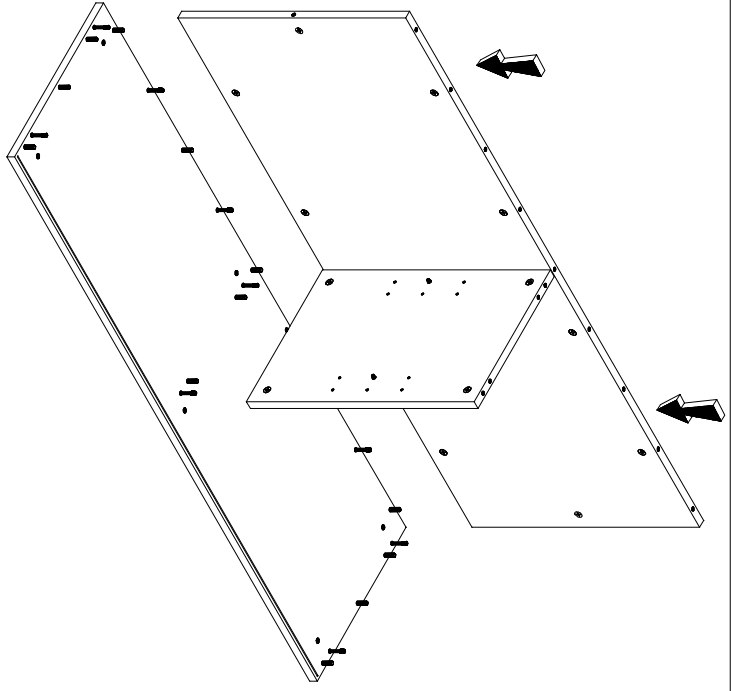

H

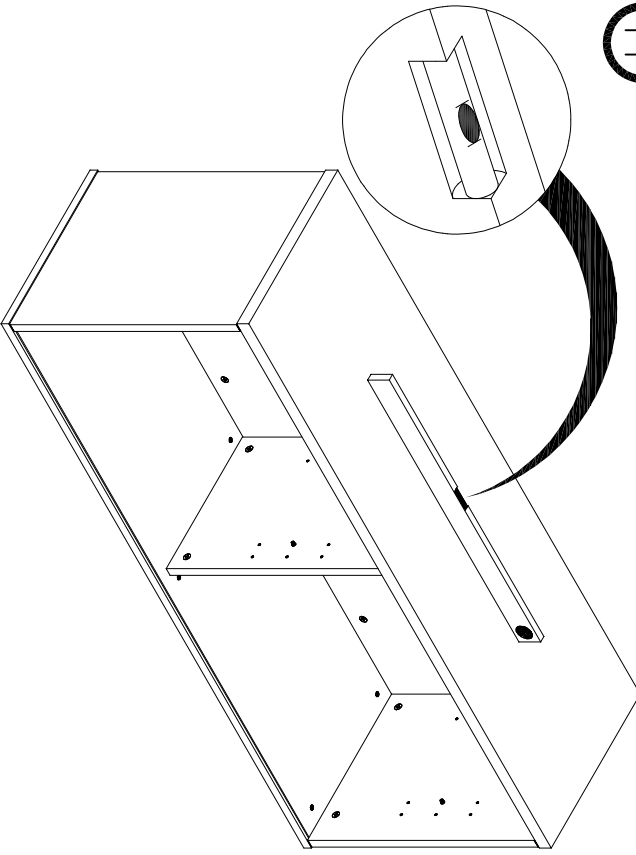

I

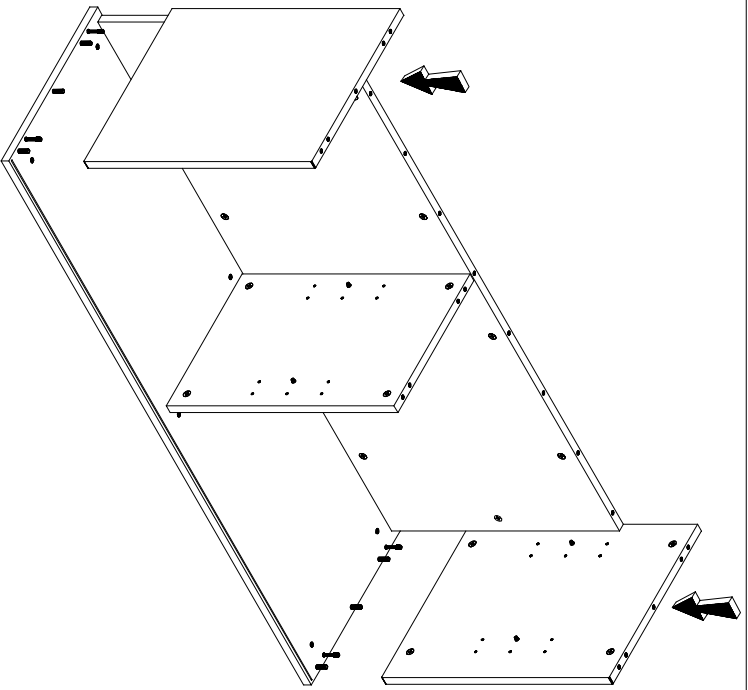

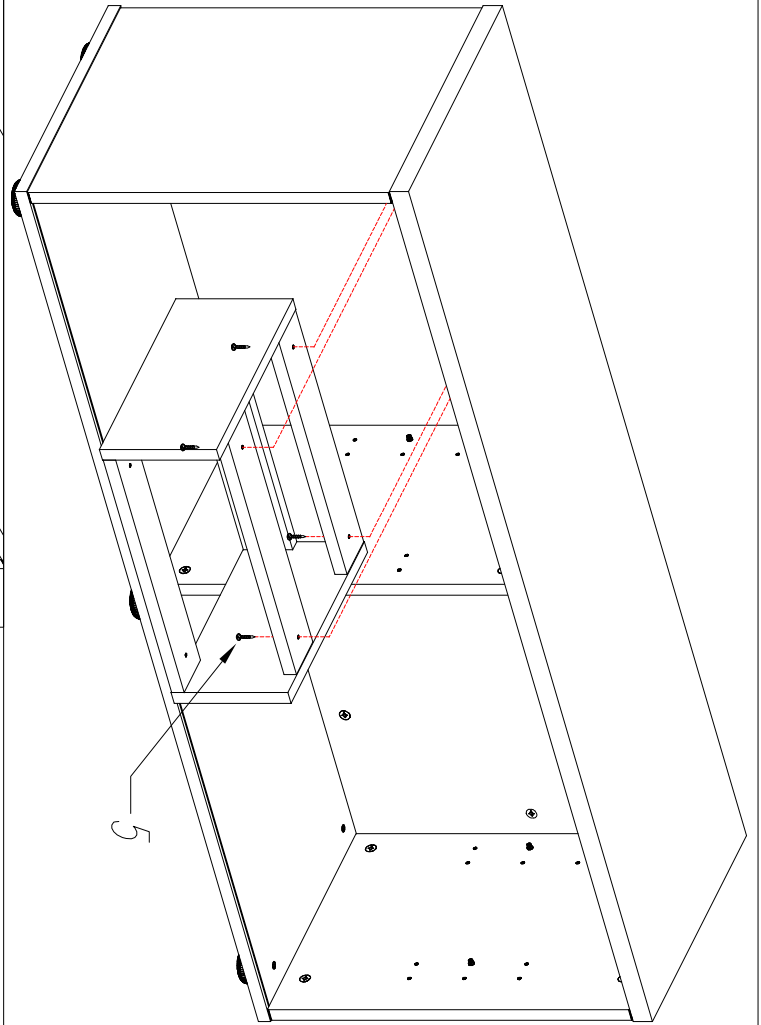
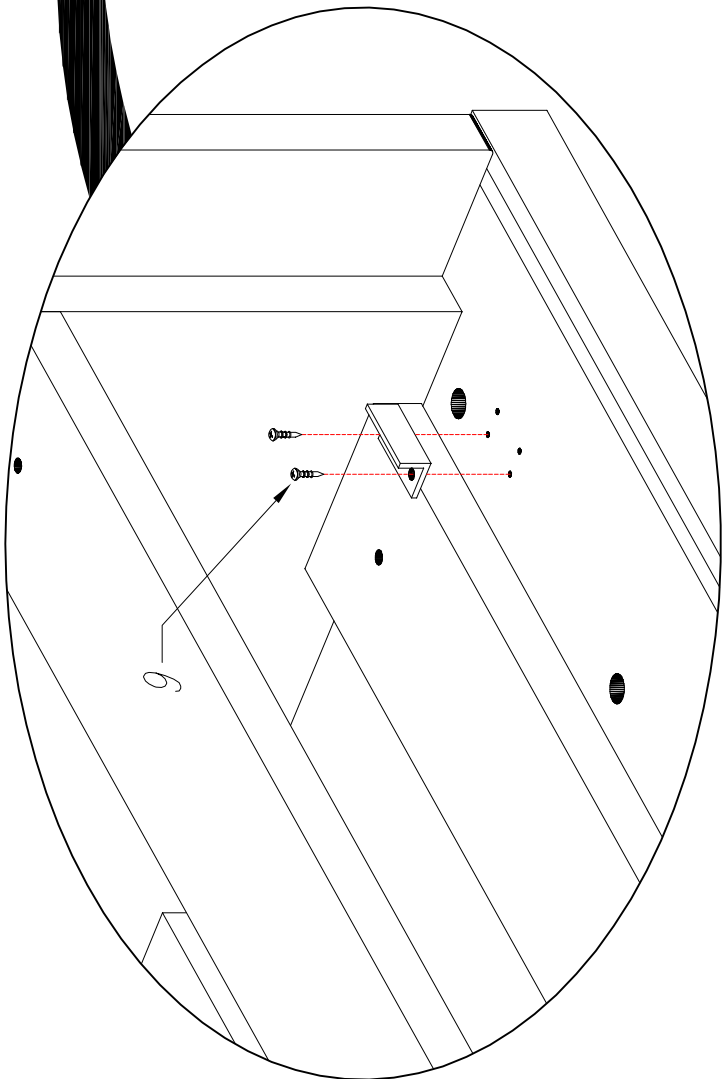
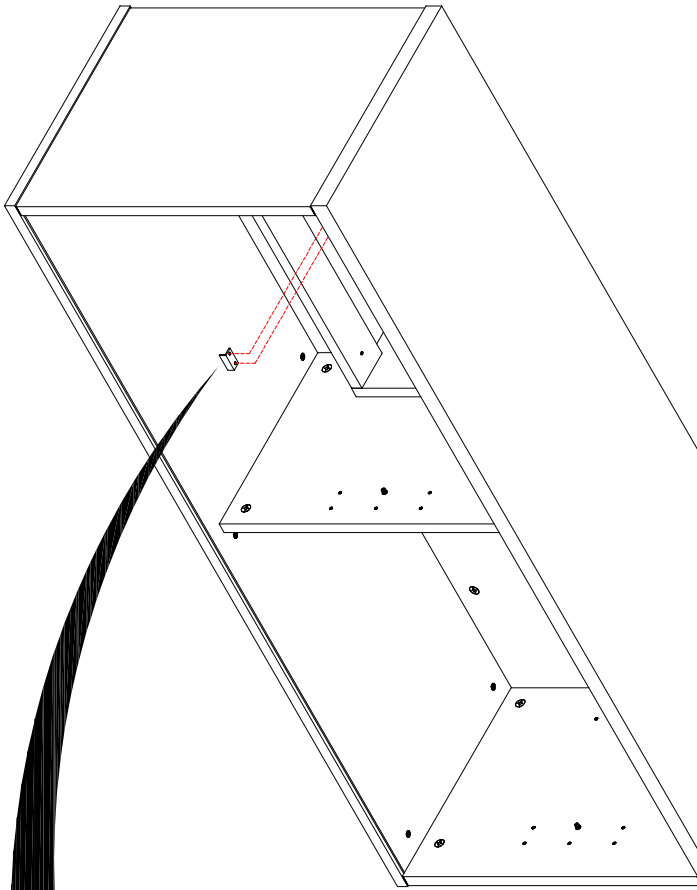

K

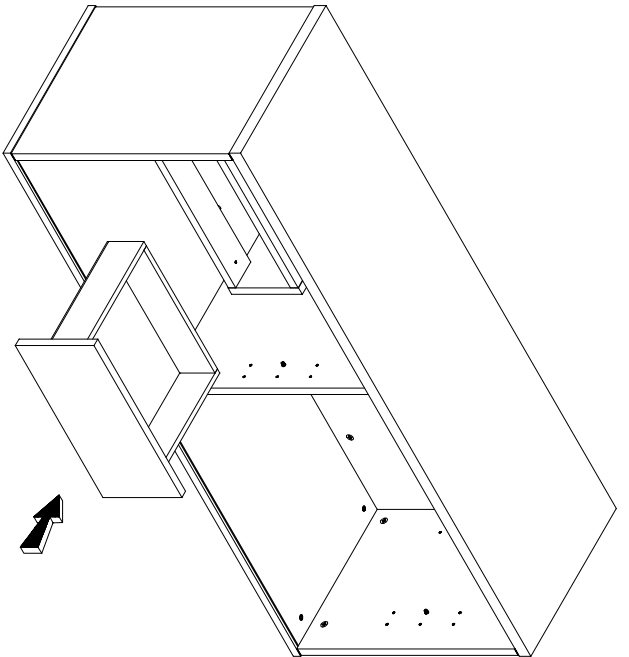

L

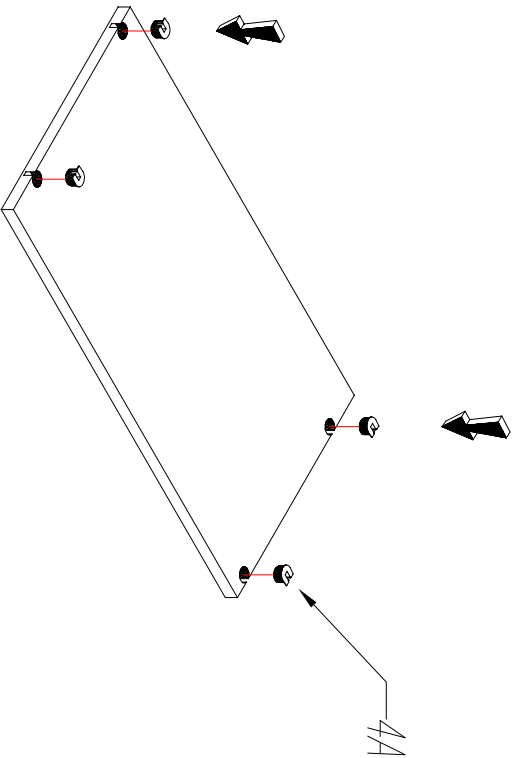

-Przykręcić śruby z
małą siłą.
-Put the screws gently.
-Anschrauben die
Schrauben zierlich.

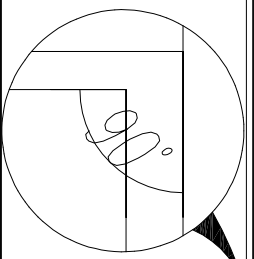
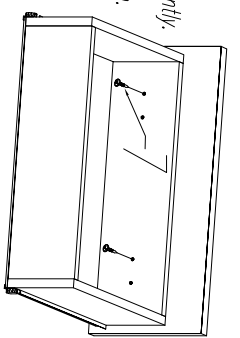

-Przykręcić śruby z
dużą siłą.
-Put the screws strongly.
-Anschrauben die
Schrauben staerklich.

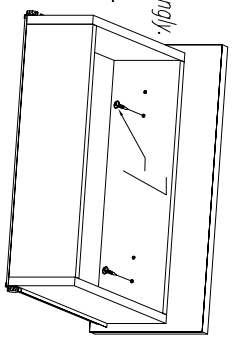

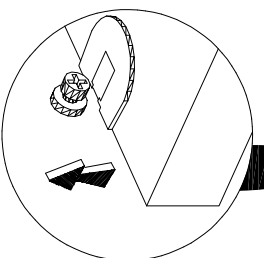
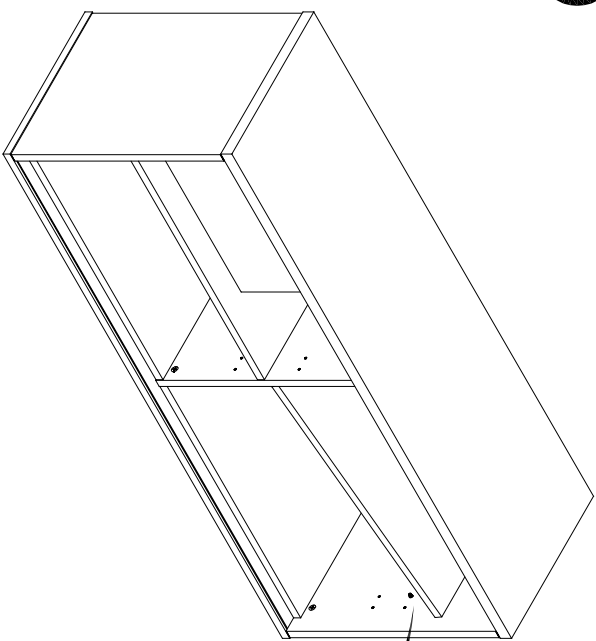

M

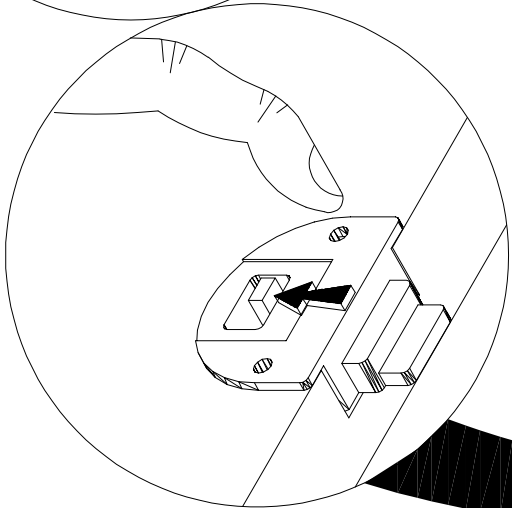
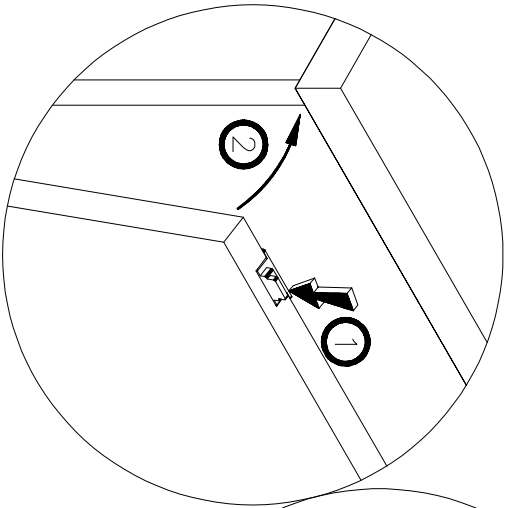
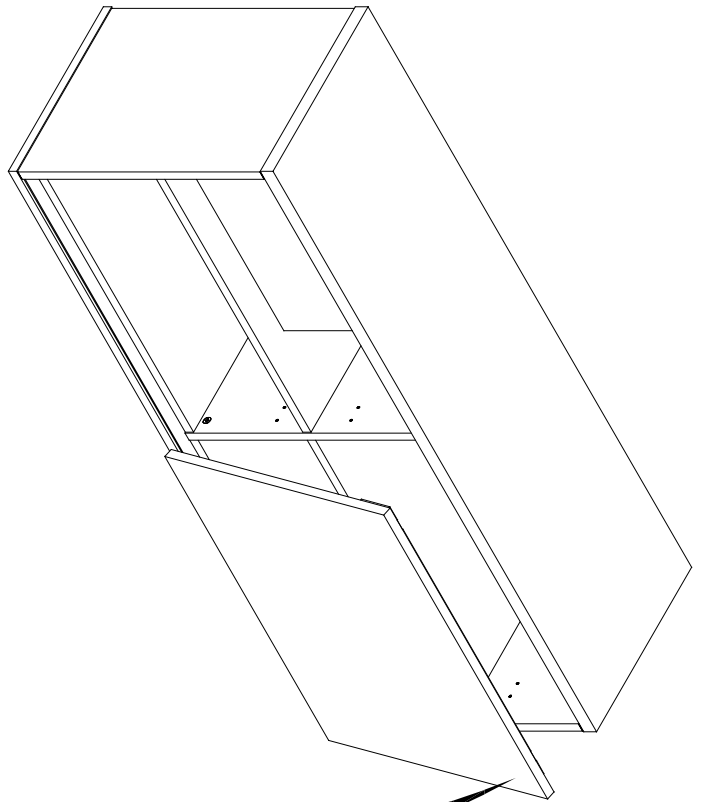
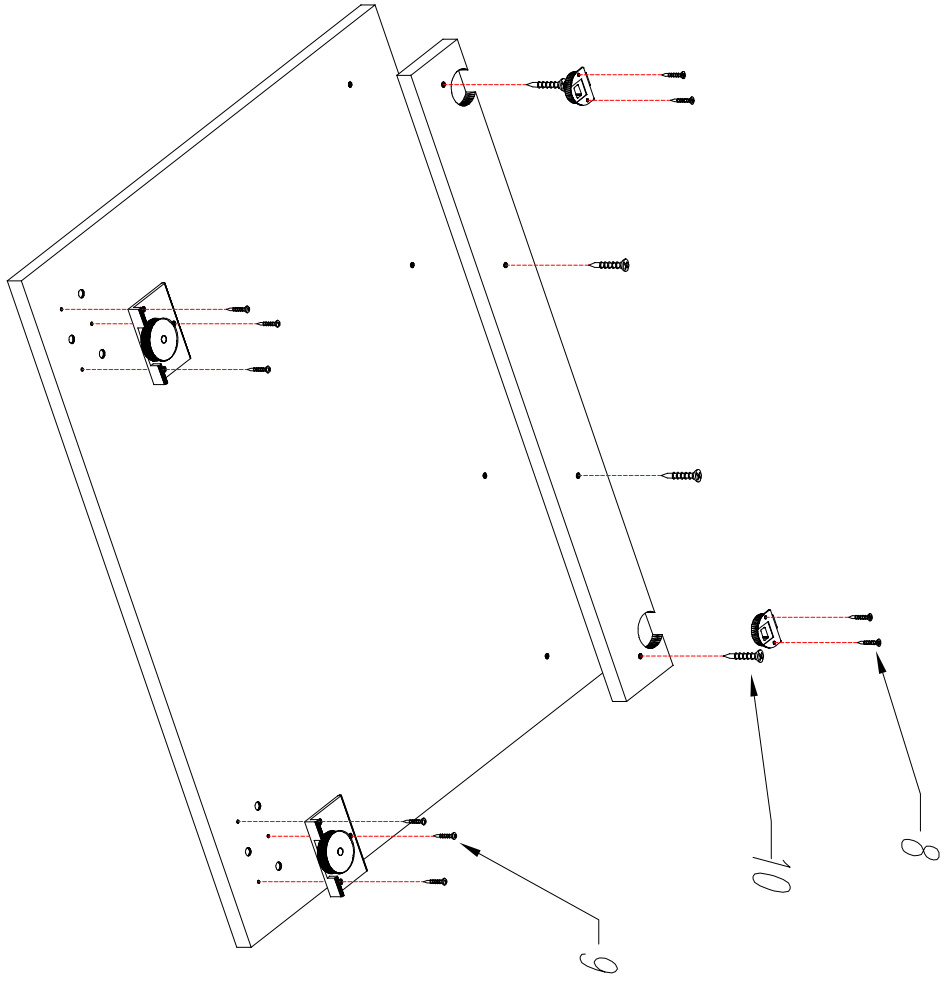

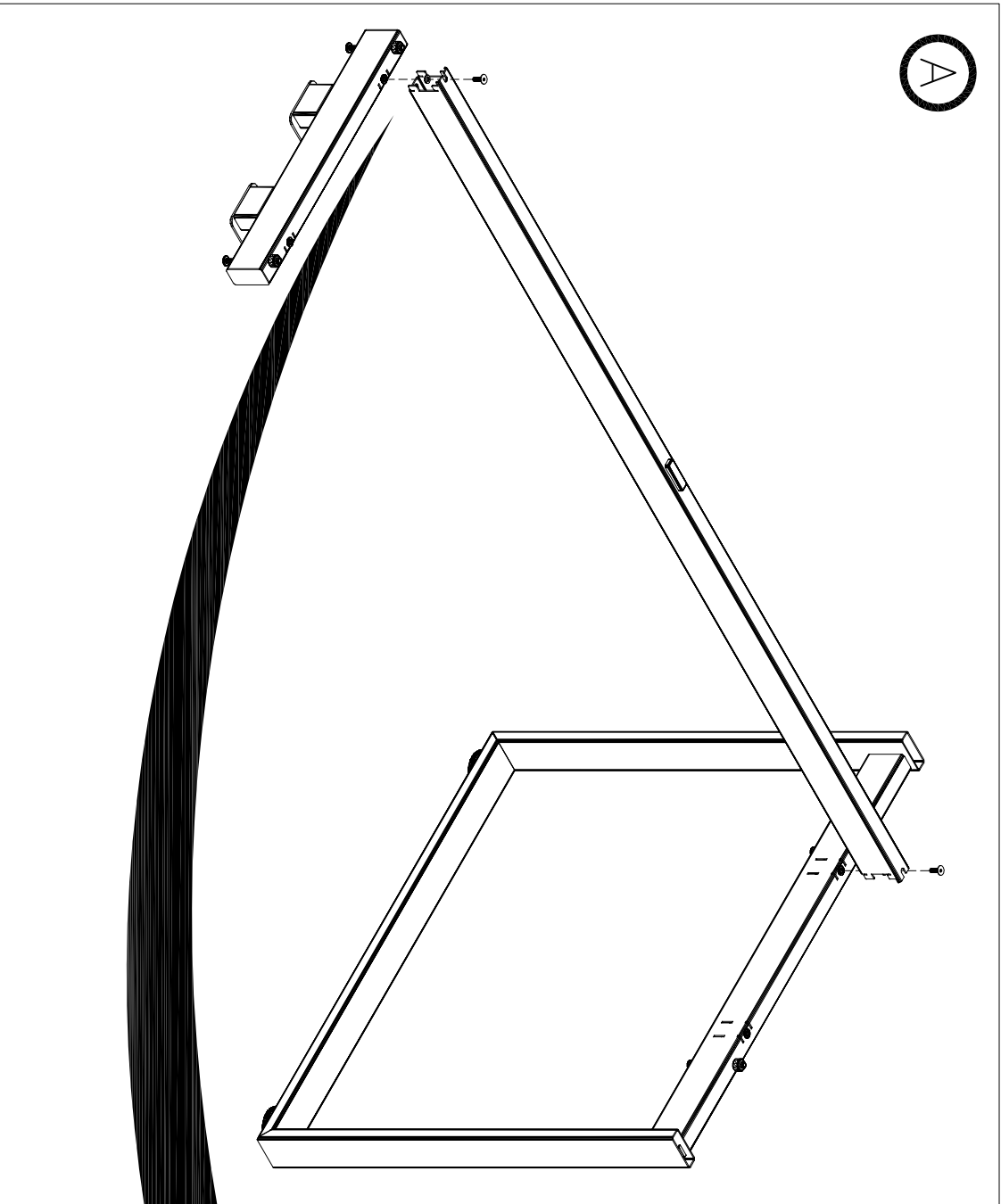

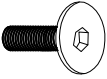

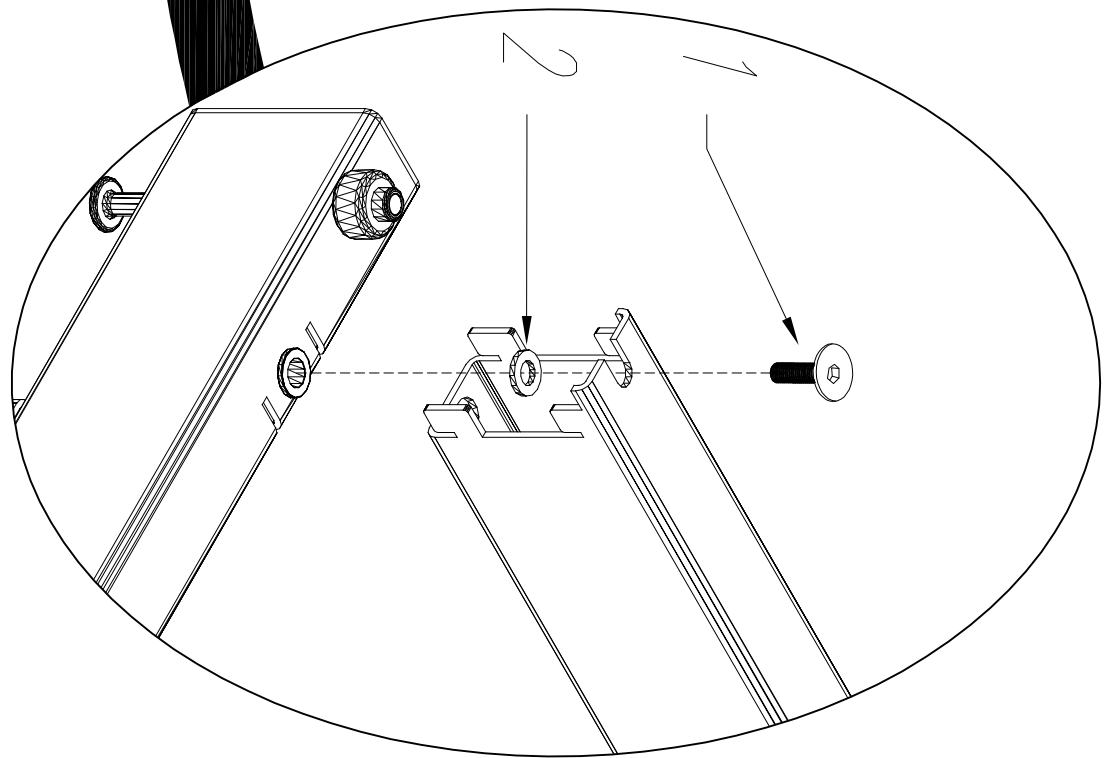

1		M6x20B
2		M6
3		M6



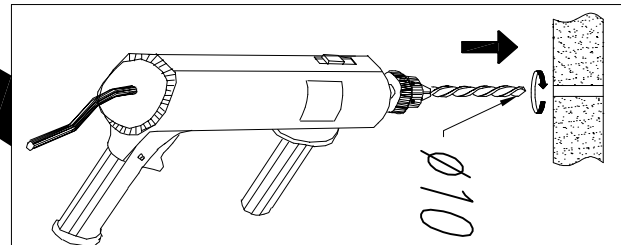
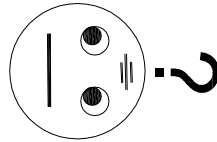
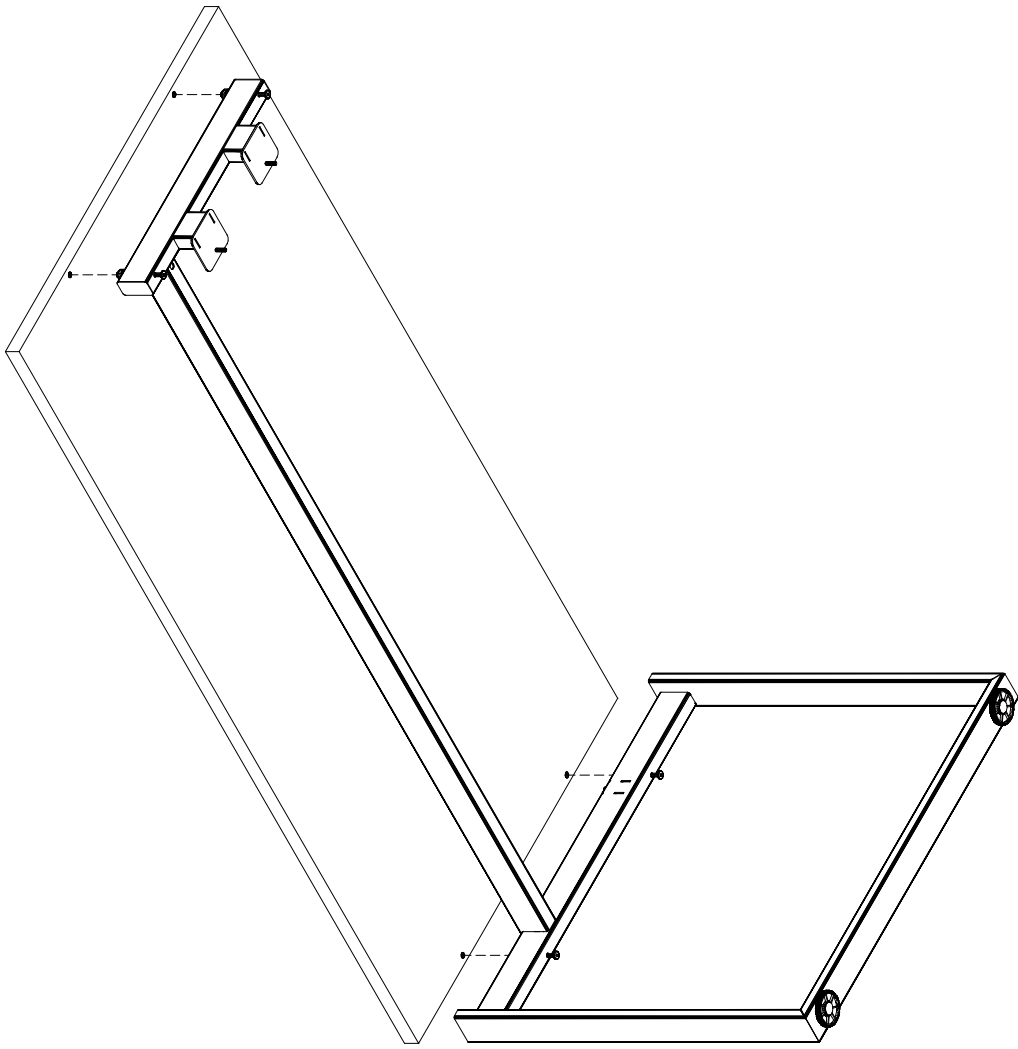

OGI

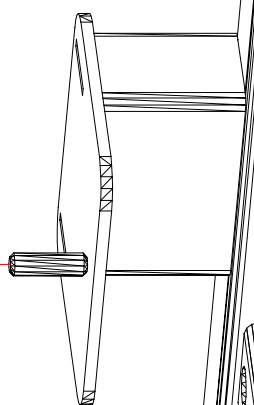
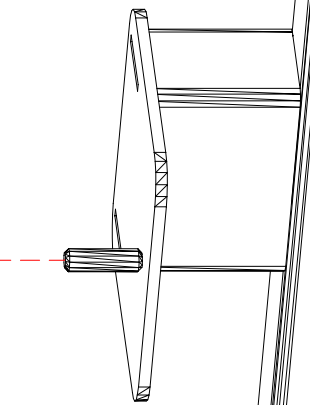
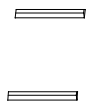

D



3

