

# Meeting tables Ogi W technical specification



.mdd

**.mdd has a leading position among manufacturers of office furniture with many awards that prove quality and continuously increase demand for it's products.**

The realities of today`s market require constant quality improvement at all levels of modern organization. This applies in particular to customer service, marketing, quality of products and also to quality of processes within the company.

Partnership relations among employees and with business partners form a base of economic growth and success of the company.

Constant investments in innovative machinery park, optimization of management systems and an expansion of production halls allow to minimize the lead times for the product of the highest quality.

**More than twenty years of experience in office furniture industry come with reference from a long list of companies and institutions to show their appreciation for an efficient and comprehensive service. .mdd is highly aware of the environment.**

Being located in the forest region with lake by it's side, .mdd takes the nature seriously and invests constantly in a modern and energy-efficient solutions to preserve the local life. Company puts emphasis on waste segregation and recycling. .mdd has been awarded for the exceptional care and involvement in waste disposal. All materials used are environmentally friendly and enjoy a high 95 % rate of being recycled.



**General informations:**

**Warranty:**

.mdd products - **5 years.**

Electrical components and fabric - **2 years.**

**Certificate - MFC:**



**Compliant with standards:**

PN-EN 15372:2010

**Boards density:**

12 mm - 690 - 750 kg/m<sup>3</sup>

18 mm - 650 - 690 kg/m<sup>3</sup>

28 mm - 610 - 630 kg/m<sup>3</sup>

36 mm - 610 - 630 kg/m<sup>3</sup>

**Assembly:**

product delivered in separate elements

**Packing:**

cardboard, perforated plastic mesh wrap

<b>Meeting tables Ogi W</b>	Date of preparation 04.05.2022	The data contained in this document is valid in the day of its preparation. Change of the product, as long as it does not affect the basic features of it, does not require consistent updates of the document.	page 2/7 <b>general informations</b>
-----------------------------	-----------------------------------	---	---

## Conference tables Ogi W

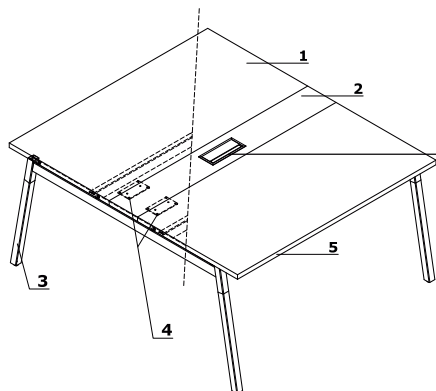

1. **Worktop** - MFC 28 mm, ABS edge
2. **MFC element** - without mediabox as standard
3. **Natural wood** - ash, with metal element, powder coated, coated with transparent varnish, profile 40 × 40 mm, spacer 10 mm between top and frame
4. **Fixing flat bar**  
**OPTIONS WITH EXTRA CHARGE:**
  5. **Worktop edge** - colour: ash natural
  6. **Top access M05**
  7. **Mediabox M04H** - 2xRJ45 (class E, cat. 6); +1 x USB + 1 x HDMI + 4x 230V
  8. **Mediabox M04** - 2xRJ45 (class E, cat. 6); +1 x USB + 4x 230V
  9. **Mediabox M06H** - OPTION WITH ADDITIONAL CHARGE - 2x230V+HDMI+USB, colour: anodised aluminium, white, black

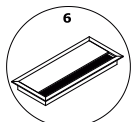

2 x RJ45  
1 x HDMI  
1 x USB

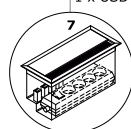

2 x RJ45  
1 x USB

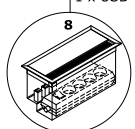

1 x HDMI  
1 x USB

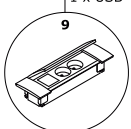

## Tables

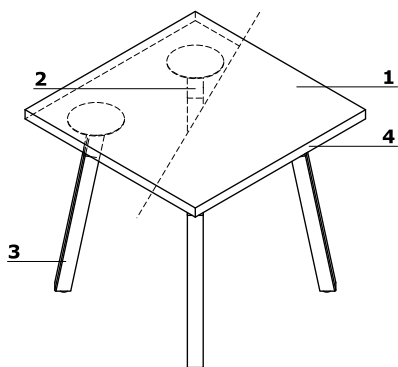

1. **Top** - MFC 18 mm, black, ABS edges 2 mm
2. **Metal element** - powder coated
3. **Frame** - metal frame , profile 40 × 40 mm, wooden leg - ash natural  
**OPTIONS WITH EXTRA CHARGE:**
  4. **Worktop edge** - colour: ash natural

Conference tables - Ogi W \*

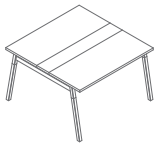

**SW22**  
1200 / 1210 / 740  
50.8 kg

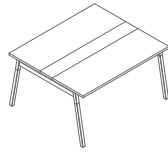

**SW24**  
1400 / 1210 / 740  
59.15 kg

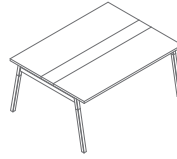

**SW26**  
1600 / 1210 / 740  
62.2 kg

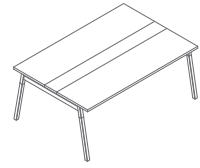

**SW28**  
1800 / 1210 / 740  
72.6 kg

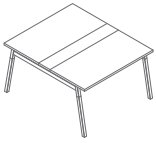

**SW42**  
1200 / 1410 / 740  
57.7 kg

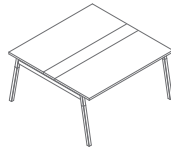

**SW44**  
1400 / 1410 / 740  
67.85 kg

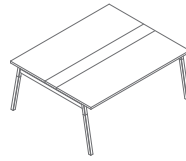

**SW46**  
1600 / 1410 / 740  
71.2 kg

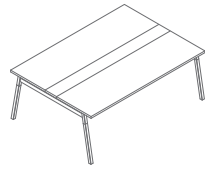

**SW48**  
1800 / 1410 / 740  
79.1 kg

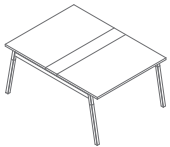

**SW32**  
1200 / 1610 / 740  
63.7 kg

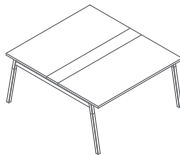

**SW33**  
1400 / 1610 / 740  
70.65 kg

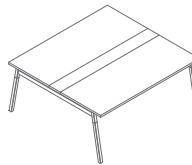

**SW34**  
1600 / 1610 / 740  
80.5 kg

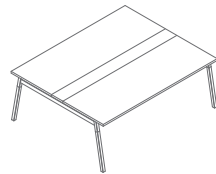

**SW35**  
1800 / 1610 / 740  
86.6 kg

\* dimensions expressed in millimeters: width x depth x height

Elements for pairing - Ogi W \*



**SW22L**  
1200 / 1210 / 740  
45.6 kg

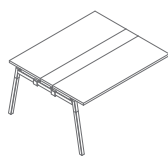

**SW24L**  
1400 / 1210 / 740  
53.95 kg

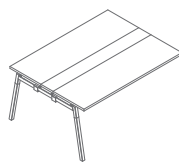

**SW26L**  
1600 / 1210 / 740  
57 kg

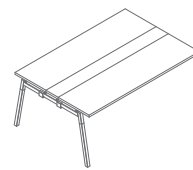

**SW28L**  
1800 / 1210 / 740  
67.4 kg

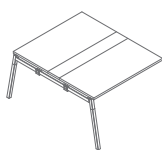

**SW42L**  
1200 / 1410 / 740  
51.9 kg

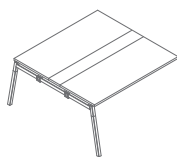

**SW44L**  
1400 / 1410 / 740  
62.05 kg

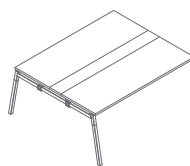

**SW46L**  
1600 / 1410 / 740  
65.4 kg

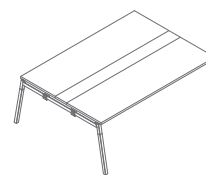

**SW48L**  
1800 / 1410 / 740  
73.3 kg

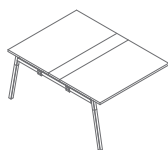

**SW32L**  
1200 / 1610 / 740  
57.5 kg

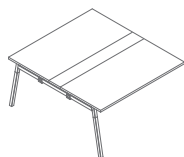

**SW33L**  
1400 / 1610 / 740  
64.45 kg

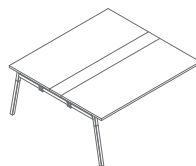

**SW34L**  
1600 / 1610 / 740  
74.3 kg

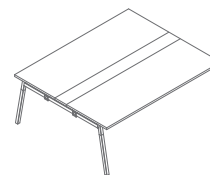

**SW35L**  
1800 / 1610 / 740  
80.4 kg

www.mdd.eu

Conference table - Ogi W \*

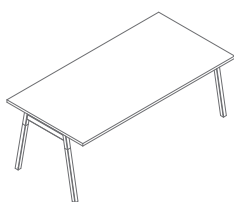

**PLD20**  
2000 / 1000 / 740  
57.8 kg

\* dimensions expressed in millimeters: width x depth x height

<b>Meeting tables Ogi W</b>	Date of preparation 04.05.2022	The data contained in this document is valid in the day of its preparation. Change of the product, as long as it does not affect the basic features of it, does not require consistent updates of the document.	page 5/7
			products

Table - Ogi W \*



**PLD82**  
800 / 800 / 550  
14.9 kg



**PLD60**  
600 / 600 / 550  
10.9 kg

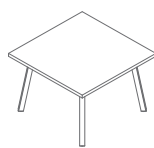

**PLD83**  
800 / 800 / 550  
18.7 kg

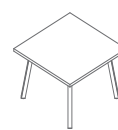

**PLD61**  
600 / 600 / 550  
13.2 kg

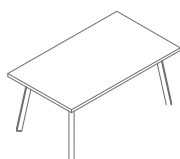

**PLD17**  
1200 / 700 / 550  
23.25 kg



**PLD80**  
800 / 800 / 740  
16.1 kg



**PLD10**  
1000 / 1000 / 740  
23.8 kg



**PLD11**  
1200 / 1200 / 740  
31.7 kg

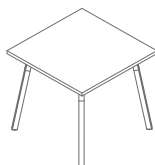

**PLD81**  
800 / 800 / 740  
20.3 kg



**PLD12E**  
2000 / 1000 / 740  
40.8 kg

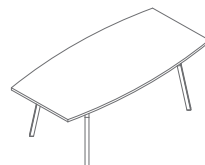

**PLD12P**  
2000 / 800-1000 / 740  
45.3 kg

\* dimensions expressed in millimeters: width x depth x height

Top



Frame, mediabox

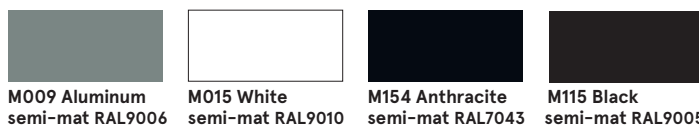

Leg



\* ATTENTION - OPTION WITH EXTRA CHARGE - worktop edge, colour: ash natural