

NEO LOW
NEO HIGH

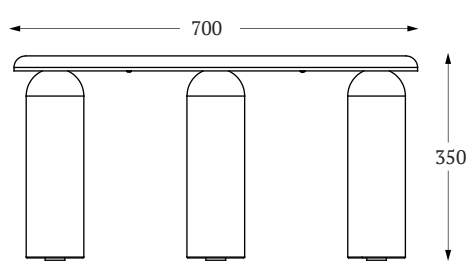

A

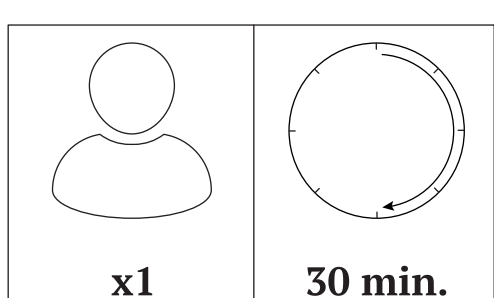
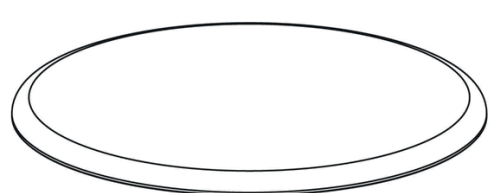

x1

B

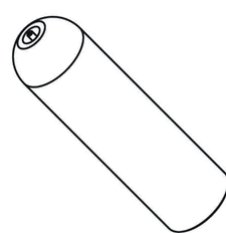

x3

1.

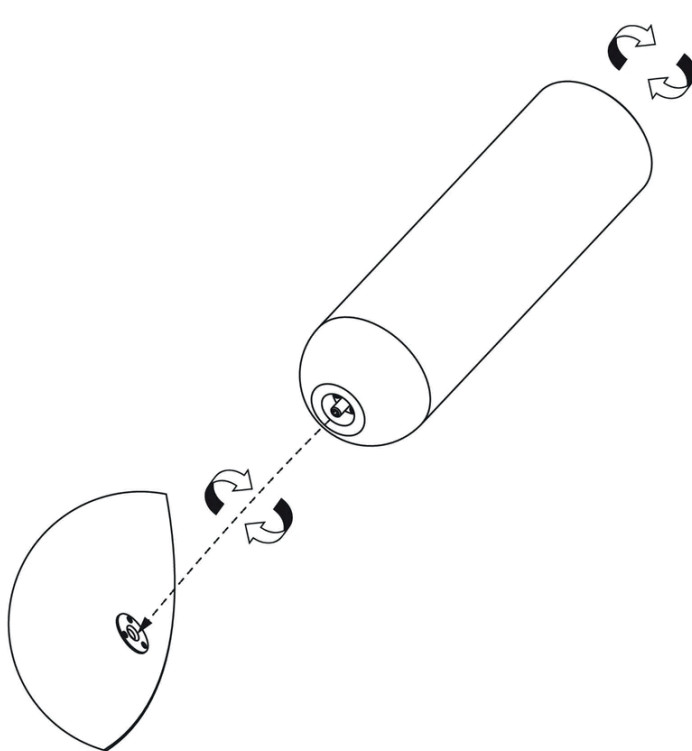

2.

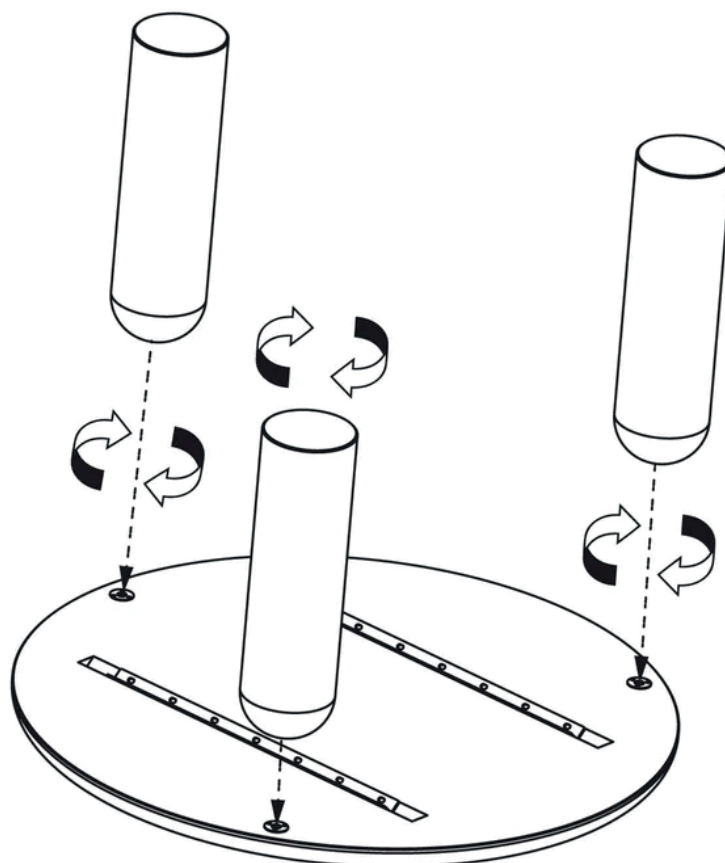

3.

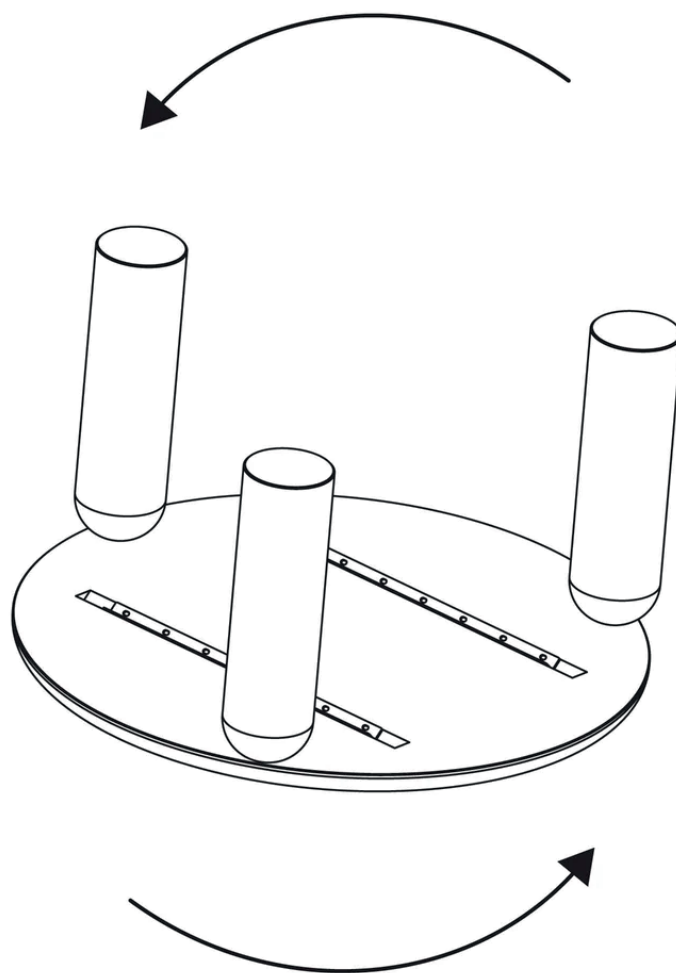

4.

