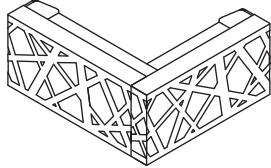
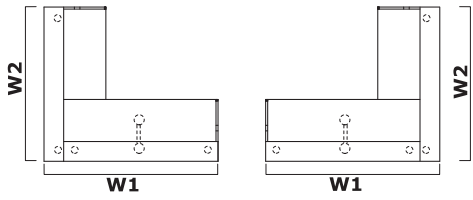
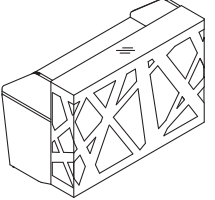
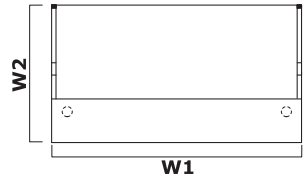
								
Symbol		Abmessungen					kg m3 pcs	Bestandteile
		W1	W2	D1	D2	H		
<b>LZG44</b>		2480	2200			1146	276.2 kg 3.224 m3 14 pcs	LZN51+LZB22+2xLZG22+LZB22M+NL41

Aufpreis						

 								
Symbol		Abmessungen					kg m3 pcs	Bestandteile
		W1	W2	D1	D2	H		
<b>LZG45</b>		2480	2200			1146	283.2 kg 3.243 m3 15 pcs	LZN51+LZK01+2xLZG22+LZB22 +LZB22M+NL41

Aufpreis						

 								
Symbol		Abmessungen					kg m3 pcs	Bestandteile
		W1	W2	D1	D2	H		
<b>LZG34</b>		1600	880			1146	126.901 kg 1.245 m3 7 pcs	LZN51+LZK01+LZG16+LZB16
<b>LZG46</b>		2200	880			1146	156.9 kg 1.69 m3 8 pcs	LZN51+LZK01+LZG22+LZB22

Aufpreis						

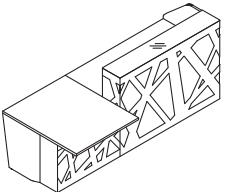
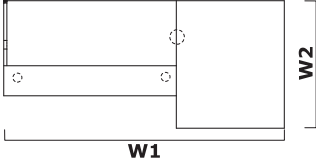
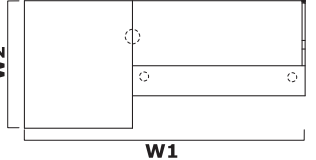
  		Abmessungen					kg m3 pcs	Bestandteile
		W1	W2	D1	D2	H		
<b>LZG50</b>		2600	1180			1146	208.401 kg 1.798 m3 11 pcs	LZN51+LZG10+LZG16+LZB16 +LZK01+NE41L
<b>LZG51</b>		3200	1180			1146	238.4 kg 2.242 m3 12 pcs	LZN51+LZG10+LZG22+LZB22 +LZK01+NE41L

Aufpreis					

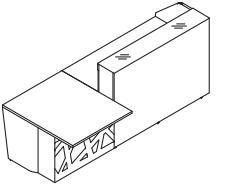
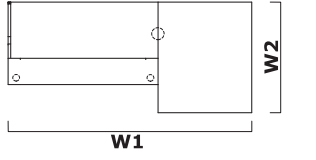
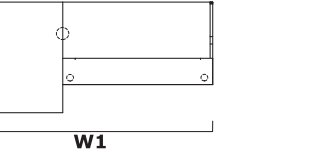
  		Abmessungen					kg m3 pcs	Bestandteile
		W1	W2	D1	D2	H		
<b>LZG56</b>		2600	1180			1146	210.401 kg 1.798 m3 11 pcs	LZG10+LZG16M+LZB16+LZN51 +LZK01+NE41L

Aufpreis					

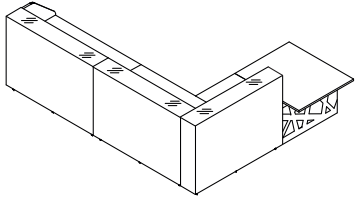
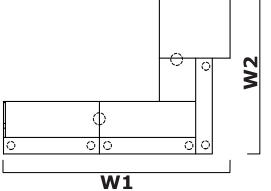
 		Abmessungen					kg m3 pcs	Bestandteile
		W1	W2	D1	D2	H		
<b>LZG57</b>		3200	2880			1146	419.202 kg 4.153 m3 23 pcs	LZN51+LZG10+LZB16M+2xLZB16+3xLZG16M+LZK01+2xNE41L

Aufpreis					

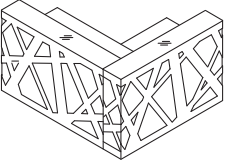
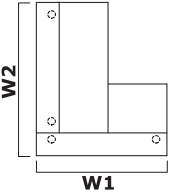
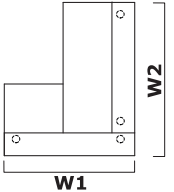
  								
Symbol		Abmessungen					kg m3 pcs	Bestandteile
		W1	W2	D1	D2	H		
<b>LZG32</b>		1600	1880			1146	217.501 kg 2.386 m3 12 pcs	LZB16M+2xLZG16+LZB16+LZN51

Aufpreis						

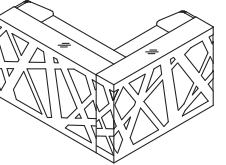
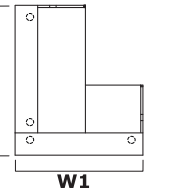
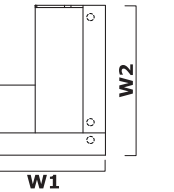
  								
Symbol		Abmessungen					kg m3 pcs	Bestandteile
		W1	W2	D1	D2	H		
<b>LZG35</b>		1600	1880			1146	224.501 kg 2.405 m3 13 pcs	LZB16M+2xLZG16+LZB16+LZN51+LZK01

Aufpreis						

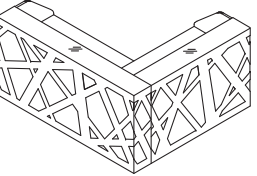
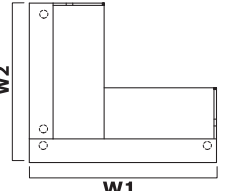
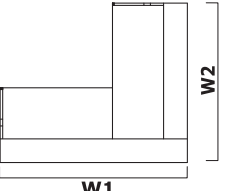
  								
Symbol		Abmessungen					kg m3 pcs	Bestandteile
		W1	W2	D1	D2	H		
<b>LZG36</b>		2200	1880			1146	252.501 kg 2.799 m3 13 pcs	LZN51+LZK01+LZB22M+LZG22 +LZB16+LZG16

Aufpreis						

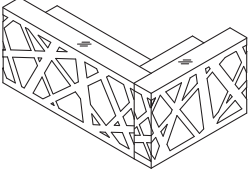
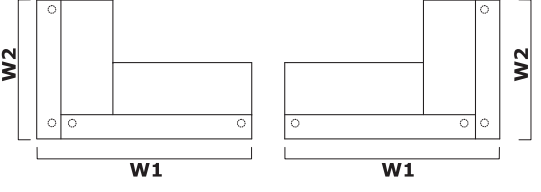
 				
Symbol	Abmessungen	kg m3	pcs	Bestandteile
	W1 W2 D1 D2 H			
<b>LZG38</b>	2480 1600		1146	245.501 kg 2.779 m3 12 pcs
				LZN51+LZB16+LZG22+LZB22M +LZG16

Aufpreis					

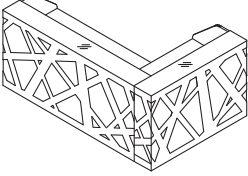
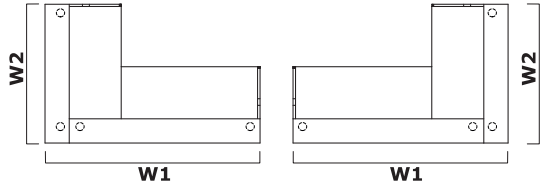
 				
Symbol	Abmessungen	kg m3	pcs	Bestandteile
	W1 W2 D1 D2 H			
<b>LZG40</b>	2480 1600		1146	252.501 kg 2.799 m3 13 pcs
				LZN51+LZK01+LZB16+LZG22 +LZB22M+LZG16

Aufpreis					

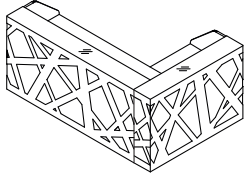
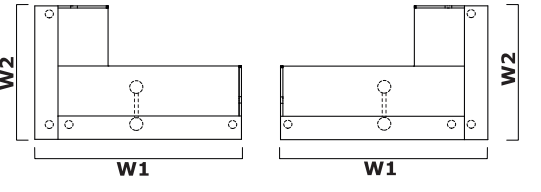
 				
Symbol	Abmessungen	kg m3	pcs	Bestandteile
	W1 W2 D1 D2 H			
<b>LZG42</b>	2480 1600		1146	252.4 kg 2.849 m3 11 pcs
				LZN51+LZK01+LZB22+LZG22 +LZB16M+LZG16+NL41

Aufpreis					

Symbol		Abmessungen					kg m3 pcs	Bestandteile
		W1	W2	D1	D2	H		
<b>LZG58</b>		3808	2880			1146	415.202 kg 4.153 m3 23 pcs	LZN51+LZK01+2xLZB16+2xLZG16+LZG16M+LZB16M+LZG10N +2xNE41L

Aufpreis						

Symbol		Abmessungen					kg m3 pcs	Bestandteile
		W1	W2	D1	D2	H		
<b>LZG52</b>		4200	1180			1146	314.802 kg 2.991 m3 17 pcs	LZN51+LZK01+LZB16+LZG16 +LZG10+LZG16+LZB16+2xNE41L
<b>LZG53</b>		4800	1180			1146	344.801 kg 3.435 m3 18 pcs	LZN51+LZK01+LZB16+LZG16 +LZG10+LZG22+LZB22+2xNE41L
<b>LZG54</b>		5400	1180			1146	374.8 kg 3.88 m3 19 pcs	LZN51+LZK01+LZB22+LZG22 +LZG10+LZG22+LZB22+2xNE41L

Aufpreis						

Symbol		Abmessungen					kg m3 pcs	Bestandteile
		W1	W2	D1	D2	H		
<b>LZG55</b>		4200	1180			1146	307.802 kg 2.971 m3 16 pcs	LZN51+LZB16+2xLZG16+LZG10 +LZB16+2xNE41L

Aufpreis						

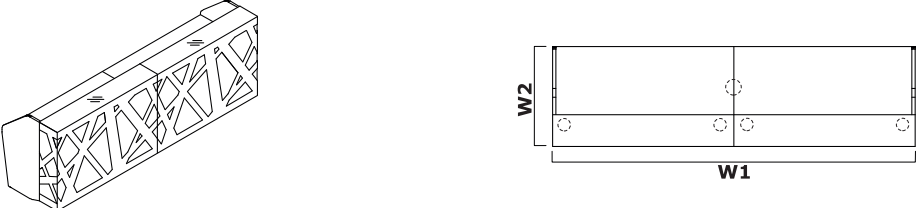

Symbol		Abmessungen					kg m3 pcs	Bestandteile
		W1	W2	D1	D2	H		
<b>LZG60</b>		3200	880			1146	233.302 kg 2.438 m3 13 pcs	LZN51+LZK01+LZB16+LZG16 +LZB16+LZG16+NE41L
<b>LZG61</b>		3800	880			1146	263.301 kg 2.882 m3 14 pcs	LZN51+LZK01+LZB16+LZG16 +LZB22+LZG22+NE41L
<b>LZG62</b>		4400	880			1146	293.3 kg 3.327 m3 15 pcs	LZN51+LZK01+LZB22+LZG22 +LZB22+LZG22+NE41L

Aufpreis						

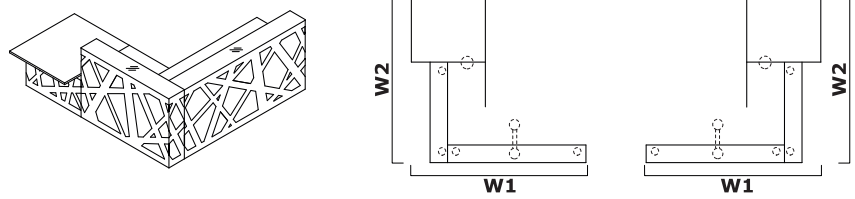

Symbol		Abmessungen					kg m3 pcs	Bestandteile
		W1	W2	D1	D2	H		
<b>LZG64</b>		2600	2780			1146	328.3 kg 3.383 m3 16 pcs	LZN51+LZB22+LZG22+LZG16 +LZB16M+LZG10+NL41+NE41L

Aufpreis						

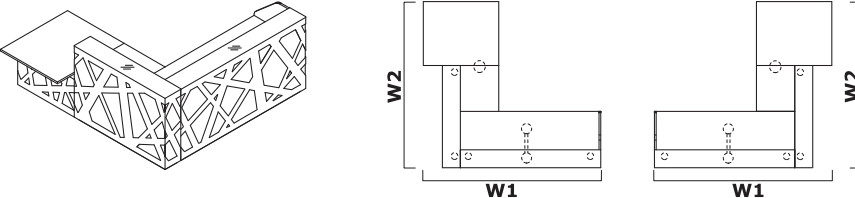

Symbol		Abmessungen					kg m3 pcs	Bestandteile
		W1	W2	D1	D2	H		
<b>LZG63</b>		2600	2780			1146	335.3 kg 3.402 m3 17 pcs	LZN51+LZK01+LZB22+LZG22 +LZG16+LZG16M+LZG10+NL41+NE41L

Aufpreis						



