

Gravity technical specification



.mdd

Mdd has a leading position among manufacturers of office furniture with many awards that prove quality and continuously increase demand for it's products.

The realities of today's market require constant quality improvement at all levels of modern organization. This applies in particular to customer service, marketing, quality of products and also to quality of processes within the company. Partnership relations among employees and with business partners form a base of economic growth and success of the company.

Constant investments in innovative machinery park, optimization of management systems and an expansion of production halls allow to minimize the lead times for the product of the highest quality.

More than twenty years of experience in office furniture industry come with reference from a long list of companies and institutions to show their appreciation for an efficient and comprehensive service.

Mdd is highly aware of the environment.

Being located in a forest region with a lake by its side, MDD takes nature seriously and invests constantly in a modern and energy-efficient solutions to preserve the local life. Company puts emphasis on waste segregation and recycling. MDD has been awarded for the exceptional care and involvement in waste disposal. All materials used are environmentally friendly and enjoy a high 95% rate of being recycled.



Technical specification · Desk

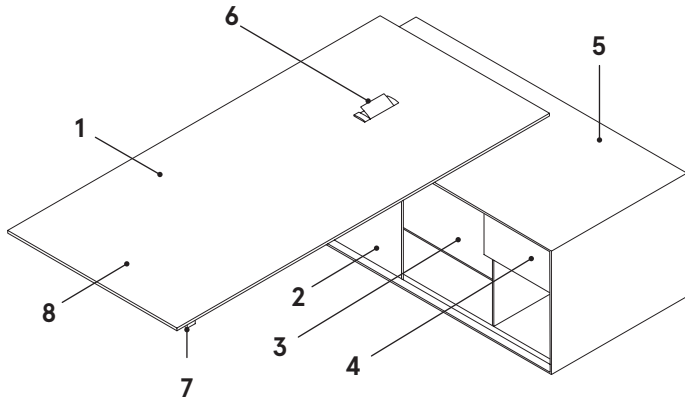

- 1. **Worktop** · Veneer/HPL, max. load 70kg
- 2. **Sliding front** · MDF, varnished 18 mm
- 3. **Shelf** · MFC 18 mm
- 4. **Drawer** · 100% extraction, self-closing, dimensions: 500x290x280 mm
- 5. **Body** · MDF lacquered 28 mm
- 6. **OPTION WITH ADDITIONAL CHARGE** · Mediabox M06 · 2x240V, colour: anodised aluminium
- 7. **Control panel**
- 8. **Electric height adjustable frame** · Powder coated steel, column dimension 150x150 mm, frame profile 60x30 mm

Control Panel + Drive

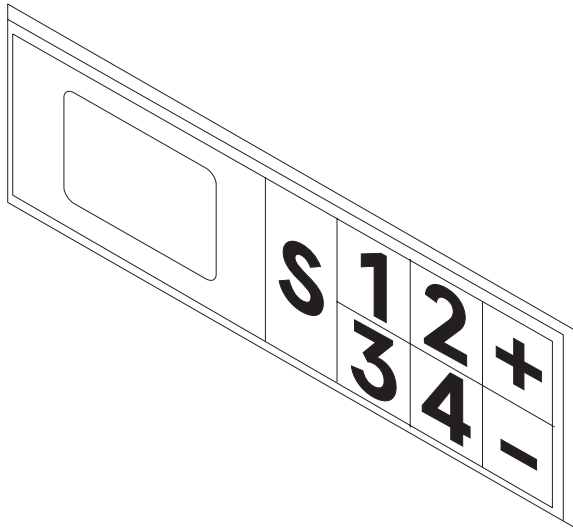

Frame Technical Specification

- Height adjustment** · 40 mm/sec, Super Soft Start-Stop
- Drive** · 2 synchronised motors with microprocessor, work control sensor
- Noise level** · ≤ 48dB
- Anti collision mechanism
- Control panel** · Electrical height adjustment · Memory
- Norms** · ISO 21016, EN 527-2, EN 527-3
- EU Directives** · 206/95 EC, UI508 1999, UL 1004 R7 06, WE DC 2004/108WE
- Power Supply** · 230V, 300W, power consumption on standby: 0.3W

www.mdd.eu

Desk dimensions

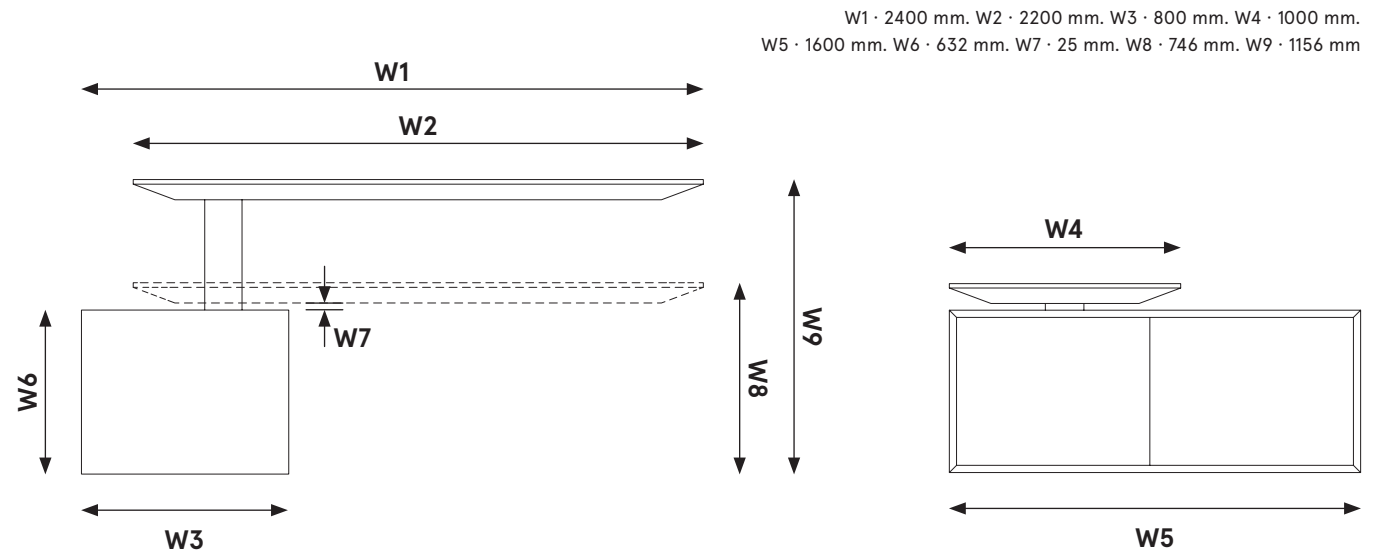

Technical specification · Multimedia stand with electric height adjustment

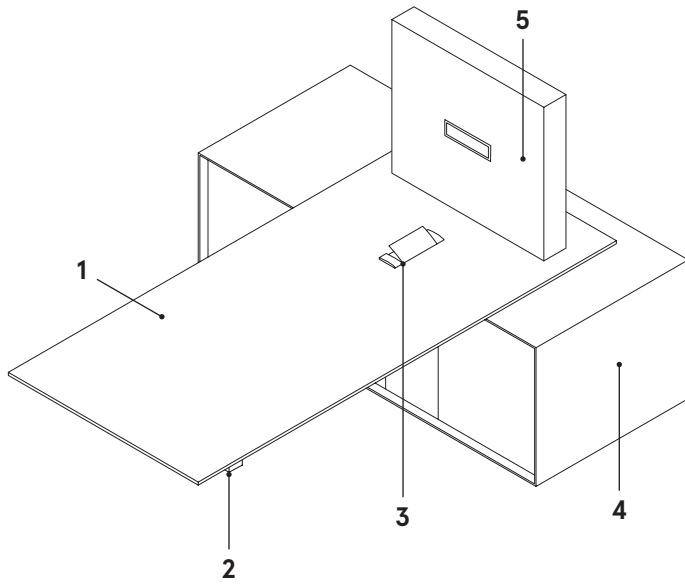

- 1. **Worktop** · Veneer/HPL, max. load 70kg
- 2. **Control panel**
- 3. **Mediabox** · 2x240V + 1xHDMI, colour: anodised aluminium
- 4. **Body** · MDF lacquered 28 mm
- 5. **Monitor handle** · VESA fixing, possible monitor dimensions: 32"-47"

Multimedia stand dimensions

www.mdd.eu

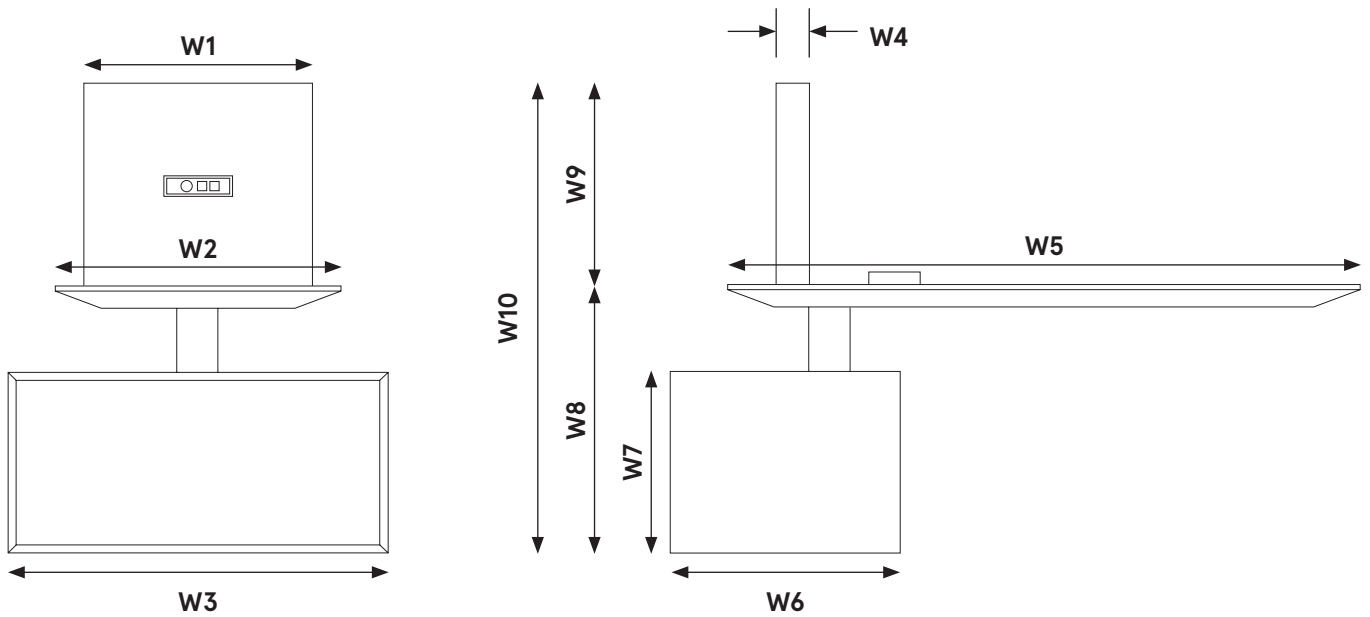

W1 · 800 mm. W2 · 1000 mm. W3 · 1350 mm. W4 · 116 mm. W5 · 2200 mm.
W6 · 800 mm. W7 · 643 mm. W8 · 946 mm. W9 · 700 mm. W10 · 1646 mm.

Technical specification · Conference table with electric height adjustment

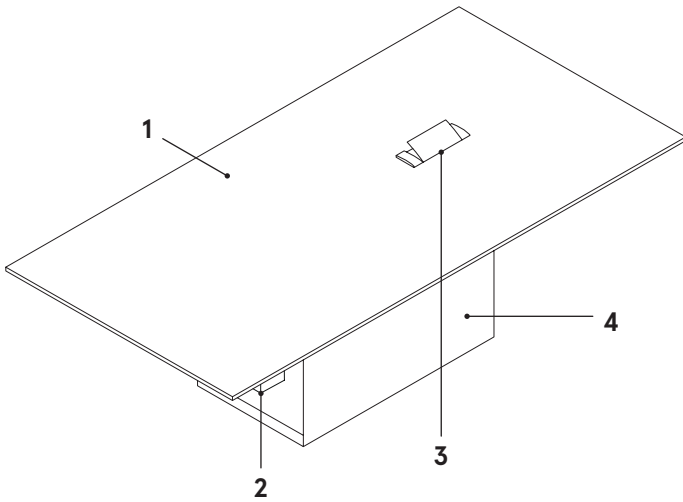

- 1. Worktop · Veneer/HPL, max. load 70kg
- 2. Control panel
- 3. OPTION WITH ADDITIONAL CHARGE · Mediabox M06 · 2x240V, colour: anodised aluminium
- 4. Body · MDF lacquered 28 mm

Conference table dimensions

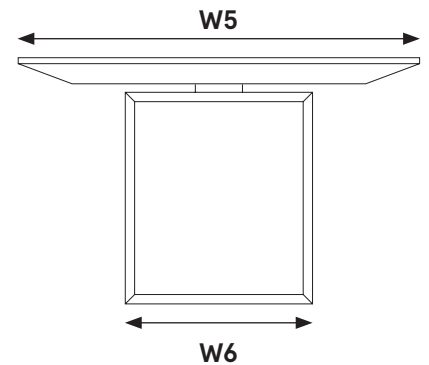
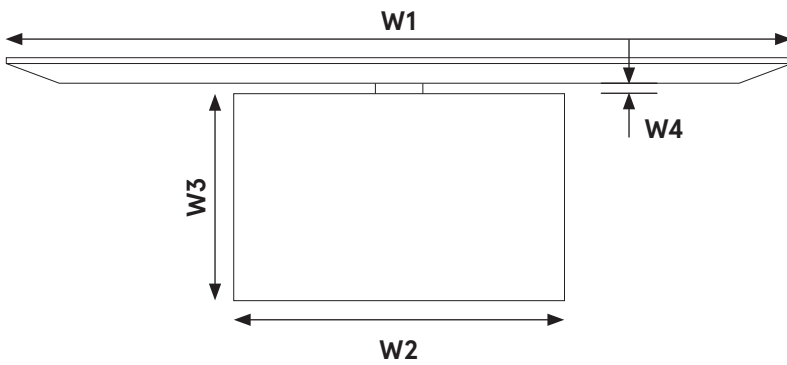

W1 · 2400 mm. W2 · 1010 mm. W3 · 642 mm.
W4 · 25 mm. W5 · 1200 mm. W6 · 560 mm.

Technical specification · Storage and shelving units

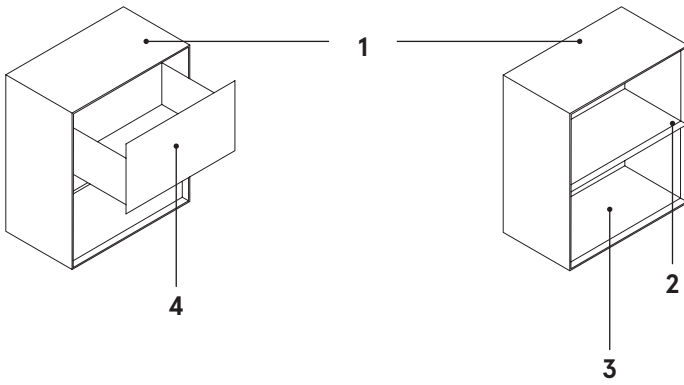

- 1. Finish · MDF, varnished 38 mm
- 2. Milled surface
- 3. Inside the cabinet · Dimensions: 740x350x380 mm
- 4. Inside the drawer · Dimensions: 686x185x350 mm

Technical specification · Coffee table

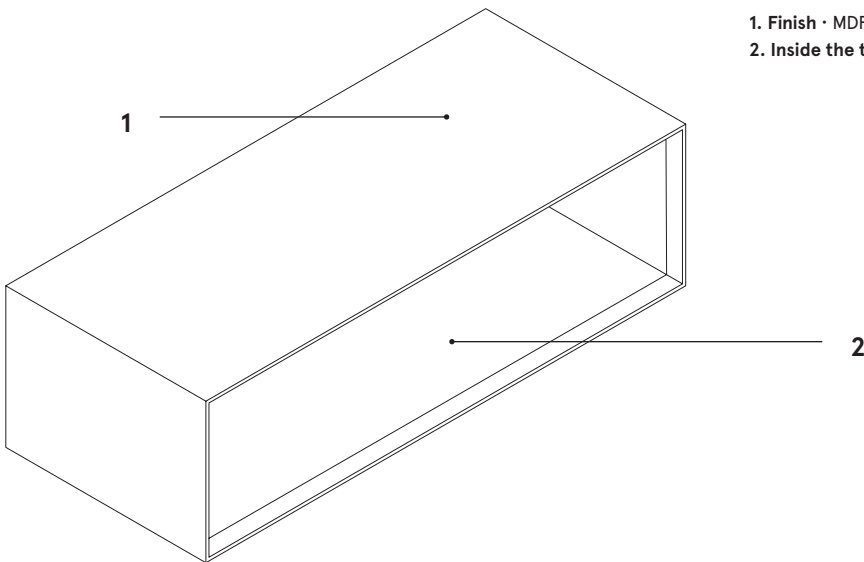

- 1. Finish · MDF, varnished 38 mm
- 2. Inside the table · Dimensions: 1142x292x462 mm

Desk · Worktop, body, frame



156 Elm



M015 White
semi-matte



159 White

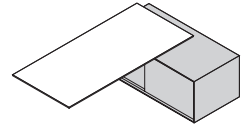
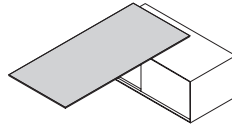

157 American
walnut



158 Graphite



M154 Anthracite
semi-matt

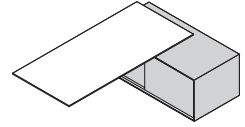
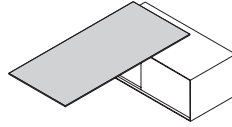

158 Graphite



158 Graphite*



M154 Anthracite
semi-matt

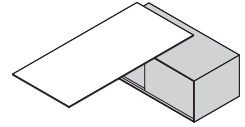
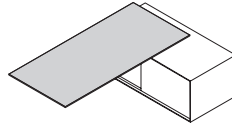

* 158 Graphite · Worktop surface covered with Fenix laminate.

Multimedia stand · Worktop, body, frame



156 Elm



M015 White
semi-matte



159 White

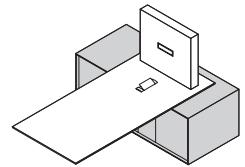
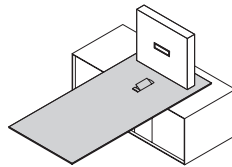

157 American
walnut



158 Graphite



M154 Anthracite
semi-matt

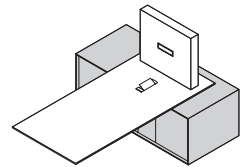
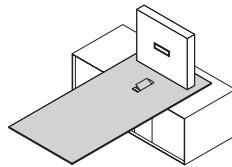

158 Graphite



158 Graphite*



M154 Anthracite
semi-matt

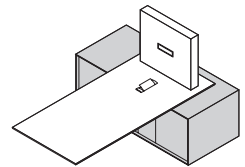
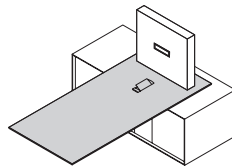

* 158 Graphite · Worktop surface covered with Fenix laminate.

Conference table · Worktop, body, frame



156 Elm



M015 White
semi-matte



159 White

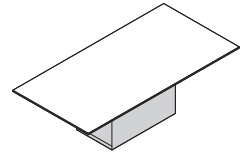
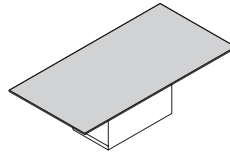

157 American
walnut



158 Graphite



M154 Anthracite
semi-matt

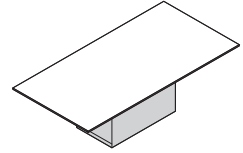
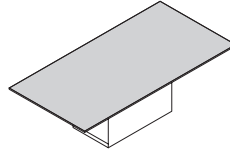

158 Graphite



158 Graphite*



M154 Anthracite
semi-matt

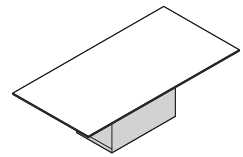
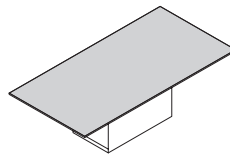

* 158 Graphite · Worktop surface covered with Fenix laminate.

Shelving units · Inside, outside



156 Elm



159 White

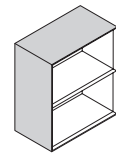
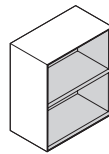

157 American
walnut



158 Graphite

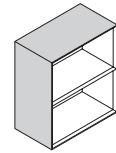
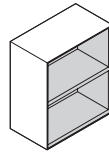

158 Graphite



158 Graphite*

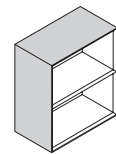
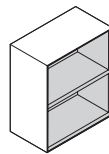

* 158 Graphite · Worktop surface covered with Fenix laminate.

Storage units · Body, drawer front, inside

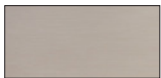

156 Elm



159 White

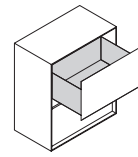
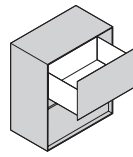

157 American walnut



158 Graphite

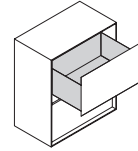
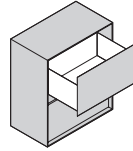

158 Graphite



158 Graphite*

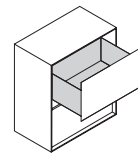
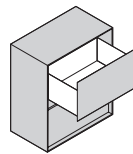

* 158 Graphite · Worktop surface covered with Fenix laminate.

Coffee table · Body outside, inside

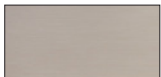

156 Elm



159 White

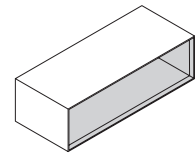
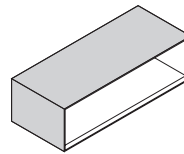

157 American walnut



158 Graphite

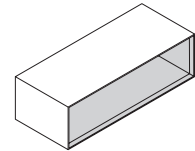
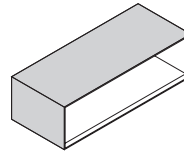

158 Graphite



158 Graphite*

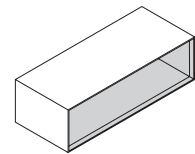
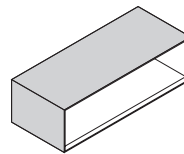

* 158 Graphite · Worktop surface covered with Fenix laminate.

Desks

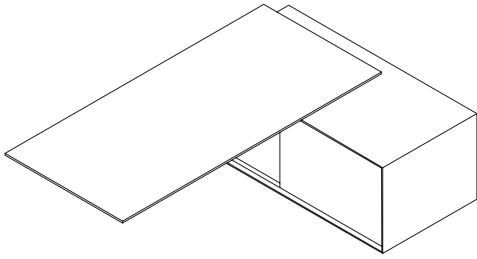

GAV1P
2400/1600/746

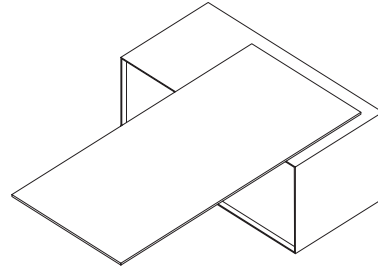

GAV1L
2400/1600/746

Conference Table

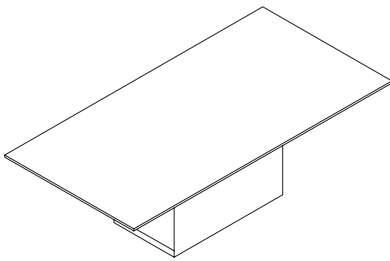

GAV5
2400/1200/750

Coffee Table

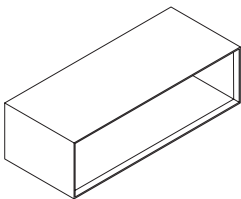

GAV6
1200/500/350

Multimedia Stand

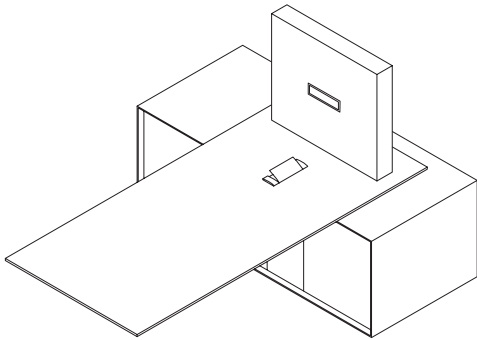

GAV10
2200/1100/750

Storages

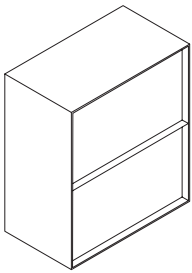

GAV15
800/450/920

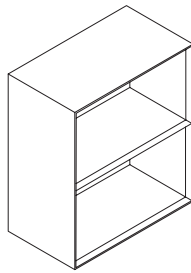

GAV16
800/450/920