

Bazalto technical specification



.mdd

MDD has a leading position among manufacturers of office furniture with many awards that prove quality and continuously increase demand for it's products.

The realities of today`s market require constant quality improvement at all levels of modern organization. This applies in particular to customer service, marketing, quality of products and also to quality of processes within the company.

Partnership relations among employees and with business partners form a base of economic growth and success of the company.

Constant investments in innovative machinery park, optimization of management systems and an expansion of production halls allow to minimize the lead times for the product of the highest quality.

More than twenty years of experience in office furniture industry come with reference from a long list of companies and institutions to show their appreciation for an efficient and comprehensive service.

MDD is highly aware of the environment.

Being located in the forest region with lake by it's side, MDD takes the nature seriously and invests constantly in a modern and energy-efficient solutions to preserve the local life. Company puts emphasis on waste segregation and recycling. MDD has been awarded for the exceptional care and involvement in waste disposal. All materials used are environmentally friendly and enjoy a high 95 % rate of being recycled.



General informations:

Warranty:

MDD products - **5 years.**

Electrical components and fabric - **2 years.**

Certificate - MFC:



Certificate - fabric:



Assembly:

product delivered in separate elements

Packing:

foam wrap

<p>Bazalto</p>	<p>Date of preparation 08.01.2020</p>	<p>The data contained in this document is valid in the day of its preparation. Change of the product, as long as it does not affect the basic features of it, does not require consistent updates of the document.</p>	<p>page 2/10 general informations</p>
-----------------------	---	--	--

Technical specification - Bazalto

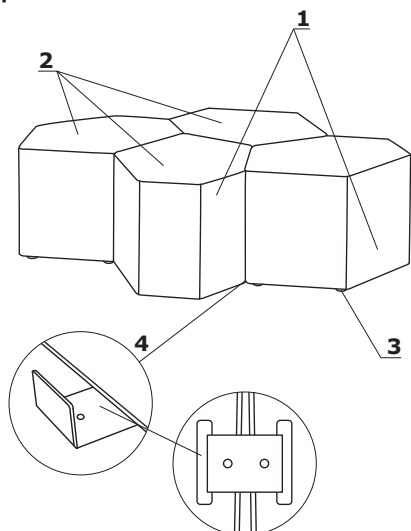

1. **Body** - MFC 18 mm, 28 mm and HDF 3 mm, fixed with confirmat screws
2. **Seat** - thickness 50 mm, sides 10 mm, covered with upholstery foam
3. **Polypropylene feet** - Ø30 mm, 6 pcs, adjustment range 15 mm
4. **Metal connecting elements** - profile 2 mm, laser-cut, powder coated, colour: black

- max. load 120 kg

Side table - Bazalto

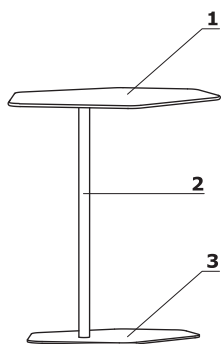

1. **Top** - mass-dyed HPL, 10 mm thick, colour: white pastel
2. **Frame** - vertical column made of tube Ø30 mm, wall thickness 2 mm, powder coated, colour: M015 - white semi-matt
3. **Base** - sheet metal, 5 mm thick

Configuration examples

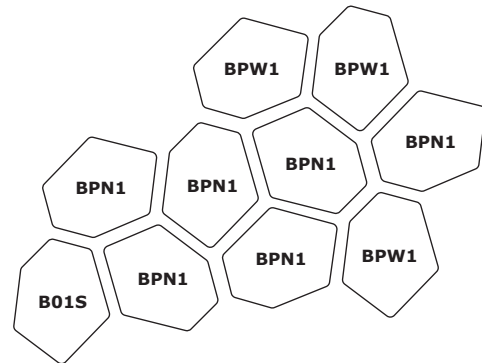
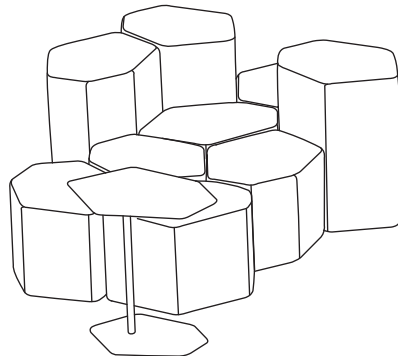
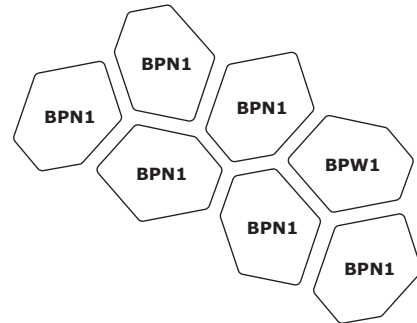
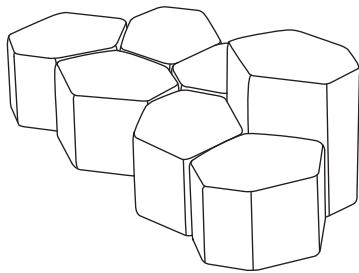
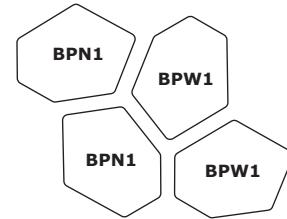
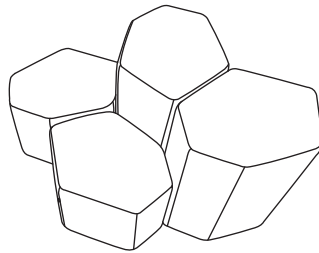
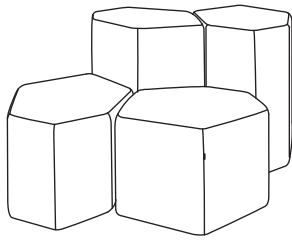
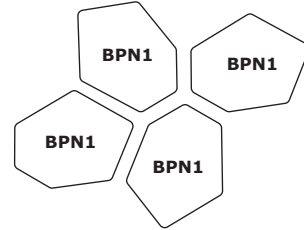
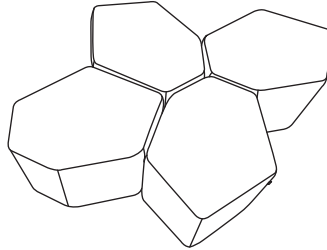
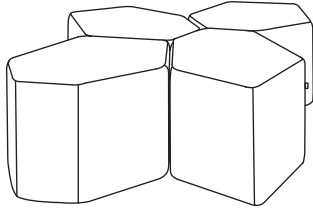
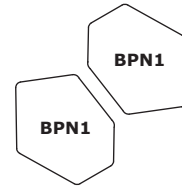
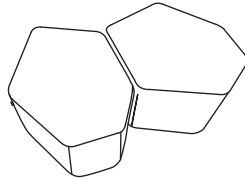
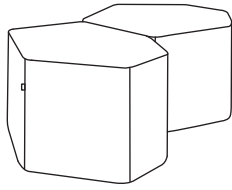

Dimensions - Bazalto

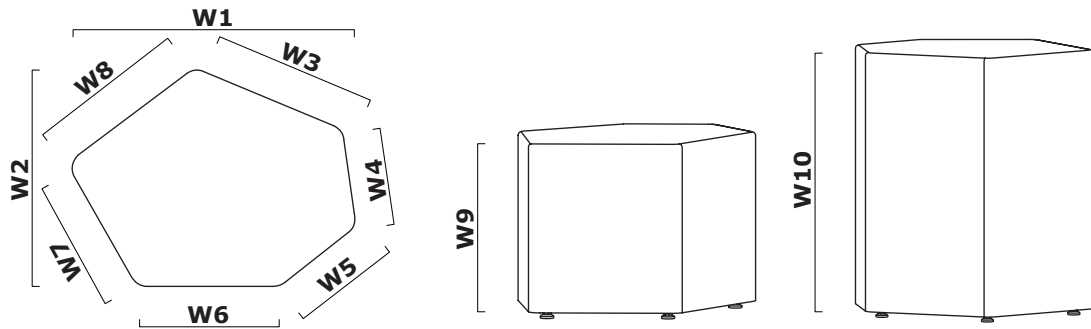

W1 - 663 | W2 - 522 | W3 - 273 | W4 - 227 | W5 - 227 | W6 - 329 | W7 - 329 | W8 - 273 | W9 - 440 | W10 - 740 |

Dimensions - side tables

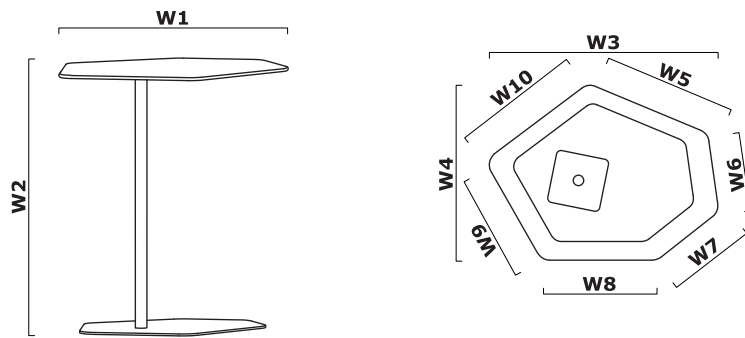

W1 - 652 | W2 - 670 | W3 - 652 | W4 - 505 | W5 - 370 | W6 - 175 | W7 - 175 | W8 - 320 | W9 - 320 | W10 - 370 |

Bazalto

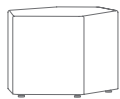

BPN1
12 kg

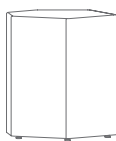

BPW1
17 kg

Side tables *



B01S
651 / 505 / 670
12 kg

* dimensions expressed in millimeters: width x depth x height

Bazalto	Date of preparation 08.01.2020	The data contained in this document is valid in the day of its preparation. Change of the product, as long as it does not affect the basic features of it, does not require consistent updates of the document.	page 6/10
			products

Fabric Nemo

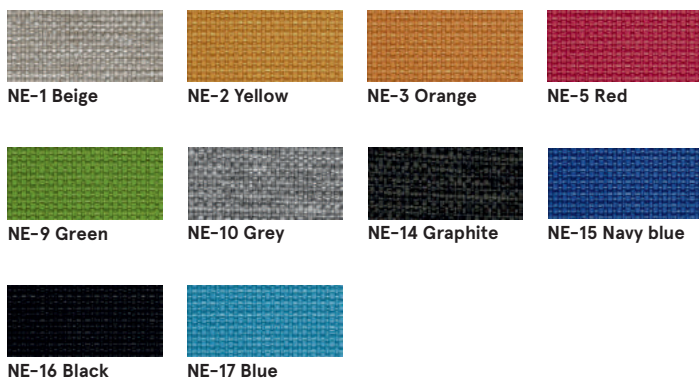

Technical data:

Material polyester 100%

Fabric weight 366g/m2

Abrasion resistance rubs PN_EN ISO 12947 - 2:2 100,000

Pilling resistance scale 1-8, max. 8, PN-EN ISO 105 - B02 (3-4)

Colour fastness to light scale 1-5, max. 5, PN-EN 1021 - 2,

Colour fastness to rubbing PN-EN 1021 - 1
skcale 1-5, max. 5, EN ISO 105x12 (wet/dry) 4-5

Fabric Medley - second price group



Technical data:

Material polyester 100%

Fabric weight 510 g/lm (16.45 oz/lin.yd.)

Abrasion resistance rubs BS EN ISO 12947-2, 75,000 cykli Martindale

Pilling resistance scale 1-5, max. 5, EN ISO 12945-2 (4)

Colour fastness to light scale 1-8, max. 8, EN ISO 105-B02 (5-7)

Colour fastness to rubbing scale 1-5, max. 5, EN ISO 105x12 (wet/dry (4-5/4-5))

Acoustic test sound absorption ISO 354

Flammability BS EN 1021-1 (cigarette)
BS 476 Part 7, Class 2
Class Uno UNI 9174 - UNI 8457
CA TB 117-2013
ASTM E 84 Class I

Fabric Atlantic * - second price group



Technical data:

Material polyester 100%

Fabric weight 530 g/lm (17.09 oz/lin.yd.)

Abrasion resistance rubs BS EN ISO 12947-2, 110,000 Martindale cycles

Pilling resistance scale 1-5, max. 5, EN ISO 12945-2 (4-5)

Colour fastness to light scale 1-8, max. 8, EN ISO 105-B02 (5-7)

Colour fastness to rubbing scale 1-5, max. 5, EN ISO 105x12 (wet/dry)

Flammability CA TB 117-2013
ASTM E 84 Class I
BS EN 1021-2 (match)
BS EN 1021-1 (cigarette)

* There is a possibility of ordering the product in full colour spectrum of Atlantic range, as per Gabriel's pattern book, within 8 weeks

Fabric Vita – second price group



Technical data:

Material Surface: 98,5% PVC, 1,5% PU
Substrate: 50% polyester, 50% Cotton

Fabric weight 850g/m2 ± 10% (1190G/lin. m ± 10%)

Abrasion resistance rubs BS EN ISO 5470-2, 100,000 Martindale cycles

Colour fastness to light 6 (ISO 105 - B02)

Colour fastness to rubbing wet: 4, dry: 4 (ISO 105 - X12)

Flammability BS EN 1021 - (cigarette)
BS EN 1021 - 2 (match)
BS 5852 - (Ignition Source 5)
BS 7176 - (Medium Hazard)

Flexes BS EN ISO 7854 - Method B,
400.000 Flexing cycles

Anti-microblal / Anti-fungal AATCC 147

Fabric River – second price group



Technical data:

Material polyester 100%

Fabric weight 300g/m2 (+/- 5%)

Abrasion resistance rubs 100,000 Martindale cycles (EN ISO 12947-1,2)

Pilling resistance EN ISO 12945-2 (5)

Colour fastness to light 4 (EN ISO 105-B02)

Colour fastness to rubbing dry: 4-5, wet: 3 (EN ISO 105-x12)

Flammability BS 5852: Part 1,
Ignition Source 0 (cigarette)
BS 5852: Part 1,
Ignition Source 1 (match)
En1021 - 2

Fabric Xtreme – third price group



Technical data:

Material 100% Trevira Clame (CS)
100% Recykling (YS)
Flame Retardant polyester.
Non metallic dyestuffs.

Fabric weight 310 g/m2 ±5% (435g/lin.m ±5%)

Abrasion resistance rubs 60,000 Martindale cycles (CS)
100,000 Martindale cycles (YS)

Colour fastness to light 6 (ISO 105 - B02)

Colour fastness to rubbing wet: 4, dry: 4 (ISO 105 - X12)

Flammability EN 1021 - 1 (cigarette),
EN 1021 - 2 (match)
BS 7176 Low Hazard,
NF P92-507 M1, DIN 4102 B1,
UNI 9175 Class 1 IM, UNI 8456,
UNI 9174 & UNI 9177 Classe Uno,
ÖNORM B 3825 & A 3800-1
NF D 60-013

Fabric Synergy - third price group

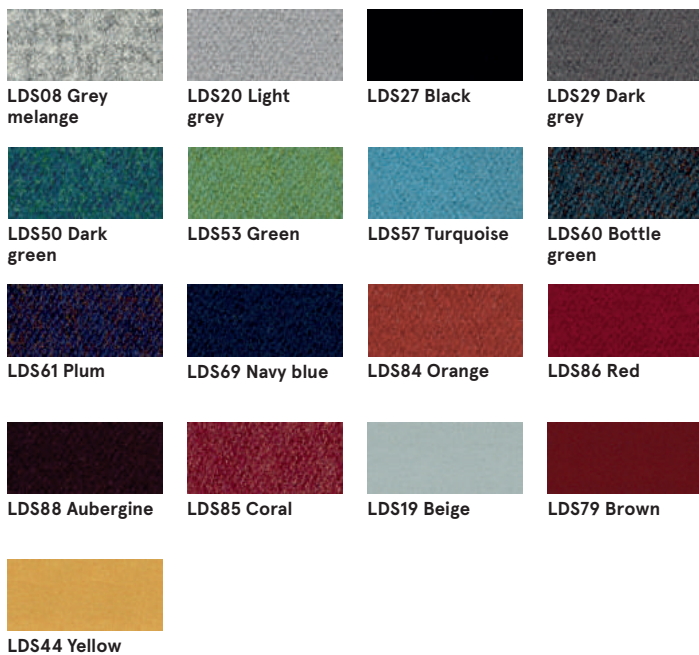

Technical data:

Material 95% Virgin Wool, 5% Poliamid

Fabric weight 400g/m2 ±5% (560 g/lin.m ±5%)

Abrasion resistance rubs Independently certified
≥100,000 Martindale cycles

Colour fastness to light 5 (ISO 105 - B02)

Colour fastness to rubbing ISO 105 - X12 - wet: 4, dry: 4

Flammability EN 1021 - 1 (cigarette, EN 1021 - 2 (match), BS 7176 Low Hazard, UNI 9175 Classe 1 IM, ÖNORM B 3825 & A 3800-1

Fabric Atlas - fourth price group



Technical data:

Material 90% new wool, 10% nylon

Fabric weight 286g/m2, 400g/lm

Abrasion resistance rubs 100,000 cykli Martindale, EN ISO 12947

Colour fastness to light ISO 105 B02: 6-7

Colour fastness to rubbing ISO 105-X12:2001, (wet/dry) 4-5/4-5

Flammability BS EN 1021-2 Match, BS EN 1021-1 Cigarette, BS 5 5852 Crib 5, BS 5852 ignition source 3, BS 5852 Part 1, NF D 60 013, UNI 9175 1IM, US Cal. Bull. 117-2013

Fabric Field2 - fourth price group



Technical data:

Material 100% Trevira CS

Fabric weight 321g/m2, 450g/lm

Abrasion resistance rubs 100,000 cykli Martindale, EN ISO 12947

Colour fastness to light ISO 105 B02: 5-7

Flammability BS EN 1021-2 Match, BS EN 1021-1 Cigarette, BS 5 5852 Crib 5, DIN 4102 B1 FAR 25.853, UNI 9177 classe 1, US Cal. Bull. 117-2013

Top B01S - HPL



30 White



08 Black

Base B01S - metal



M015 White
semi-matt RAL9010



M115 Black
semi-matt RAL9005