

# Hako technical specification



.mdd

**MDD has a leading position among manufacturers of office furniture with many awards that prove quality and continuously increase demand for its products.**

The realities of today's market require constant quality improvement at all levels of modern organization. This applies in particular to customer service, marketing, quality of products and also to quality of processes within the company.

Partnership relations among employees and with business partners form a base of economic growth and success of the company.

Constant investments in innovative machinery park, optimization of management systems and an expansion of production halls allow to minimize the lead times for the product of the highest quality.

**More than twenty years of experience in office furniture industry come with reference from a long list of companies and institutions to show their appreciation for an efficient and comprehensive service.**

**MDD is highly aware of the environment.**

Being located in the forest region with lake by its side, MDD takes the nature seriously and invests constantly in a modern and energy-efficient solutions to preserve the local life. Company puts emphasis on waste segregation and recycling. MDD has been awarded for the exceptional care and involvement in waste disposal. All materials used are environmentally friendly and enjoy a high 95 % rate of being recycled.



**General informations:**

**Warranty:**

MDD products - **5 years.**

Electrical components and fabric - **2 years.**

**Boards density:**

12 mm - 690 - 750 kg/m<sup>3</sup>

18 mm - 650 - 690 kg/m<sup>3</sup>

28 mm - 610 - 630 kg/m<sup>3</sup>

36 mm - 610 - 630 kg/m<sup>3</sup>

**Certificate - MFC:**



**Certificate - fabric:**



**Assembly:**

product delivered in separate elements

**Packing:**

wooden crates; separate elements situated on wooden racks; panels protected by a foil

Office booth Hako

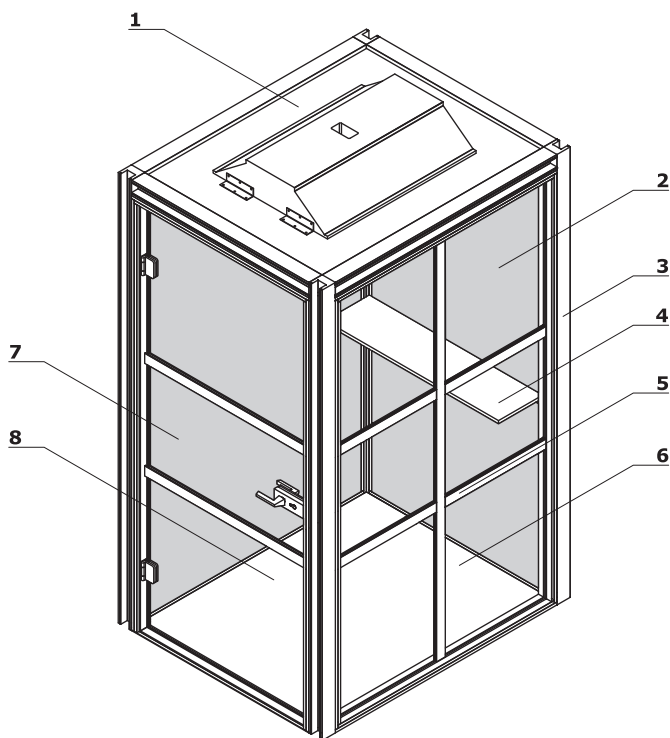

1. **Ceiling** - upholstered, equipped with lighting and ventilation system
2. **Upholstered wall** - full, 75 mm thick, upholstered on both sides, acoustic properties
3. **Columns** - 75x75 mm, powder coated
4. **Shelf** - 12 mm MDF, colour: black, can be mounted only to upholstered walls with 1000 mm width
5. **Aluminium strips** - 5 mm thick
6. **Glass wall** - toughened glass, 6 mm thick
7. **Glass door** - toughened glass, 8 mm thick, equipped with hinges and gasket system that extends the acoustic properties of the booth
8. **OPTION WITH EXTRA CHARGE - floor** - melamine plate + acoustic covering (21 mm thickness), colour: graphite

Electric systems available:

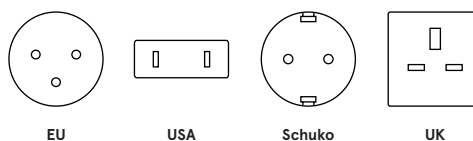

Additional information:

- walls - the highest class of acoustics
- certificated Sonic technology used in acoustic panels
- air function - fans work for additional 5 minutes after leaving the booth
- LED SLIM panel, 60x60 cm, external power supply; 40W, 3200lm, 4000k, 220-240V AC, 120°, RA>80, PF>0.9, white, STANDARD LINE

Mediabox - dimensions (mm)

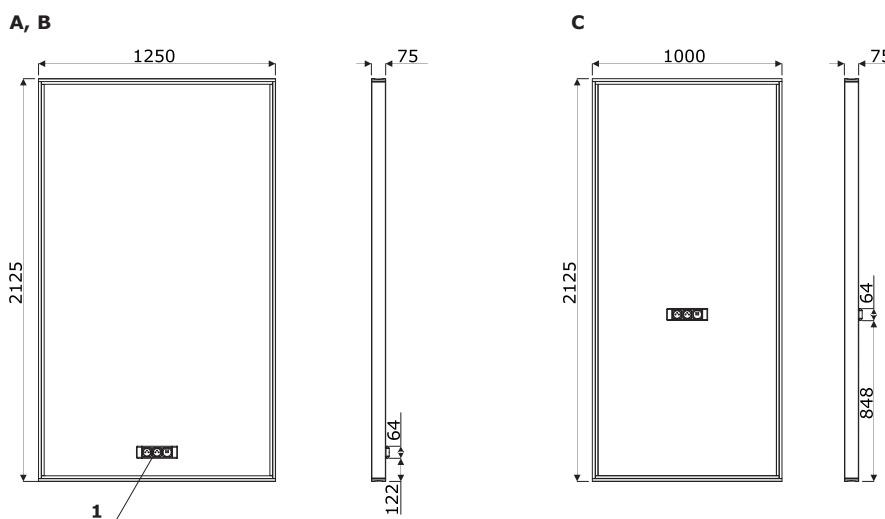

Attention! In standard the booth has no floor what allows, among other things, situating the booth in any place as well as easy cable management.

<p><b>Hako</b></p>	<p>Date of preparation 19.02.2020</p>	<p>The data contained in this document is valid in the day of its preparation. Change of the product, as long as it does not affect the basic features of it, does not require consistent updates of the document.</p>	<p>page 3/11 <b>technical specification</b></p>
--------------------	---	--	---

1. Mediabox - 2x230V + 1xUSB + 1xUSB type C
- A - on the left wall near the floor
  - B - on the right wall near the floor
  - C - on the shorter wall above 740mm height
  - HK01 (possible configurations: A, C, AC)
  - HK04 (possible configurations: A, B, AB)
  - HK021 (possible configurations: A, B, C, AB, AC, BC, ABC)

**Legend:**

- \* fan (located near the floor) - Attention! It is suggested not to block fans to ensure the proper airflow rate
- \*\* motion sensor
- \*\*\* wireless light switch - which can be situated in any place
- \*\*\*\* left / right door option

**HK01**

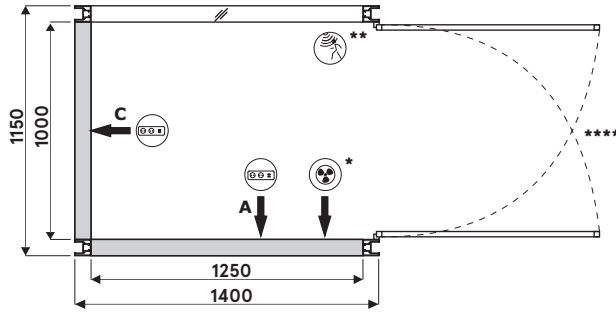

**HK021**

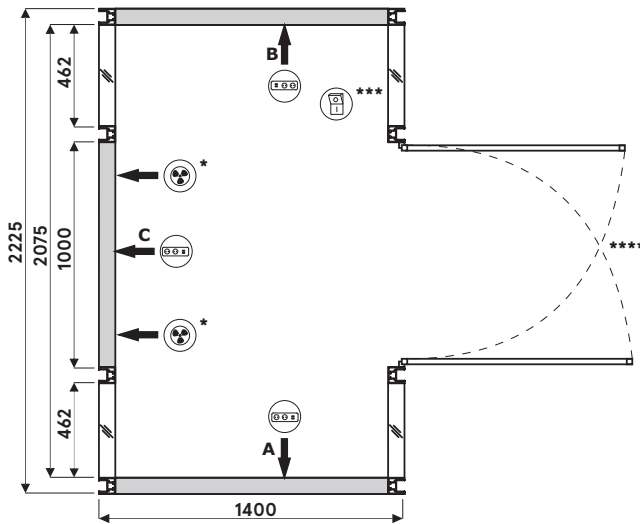

**HK04**

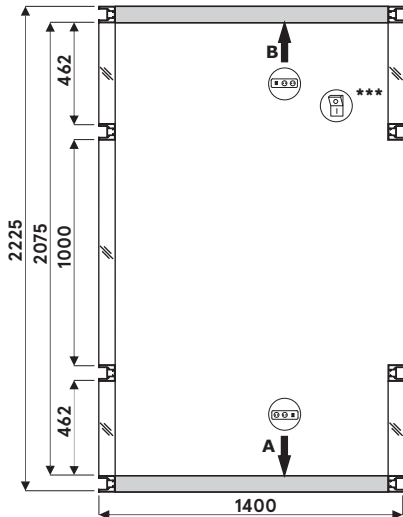

Legend:

- \* fan (located near the floor) - Attention! It is suggested not to block fans to ensure the proper airflow rate
- \*\* motion sensor
- \*\*\* wireless light switch - which can be situated in any place

HK03

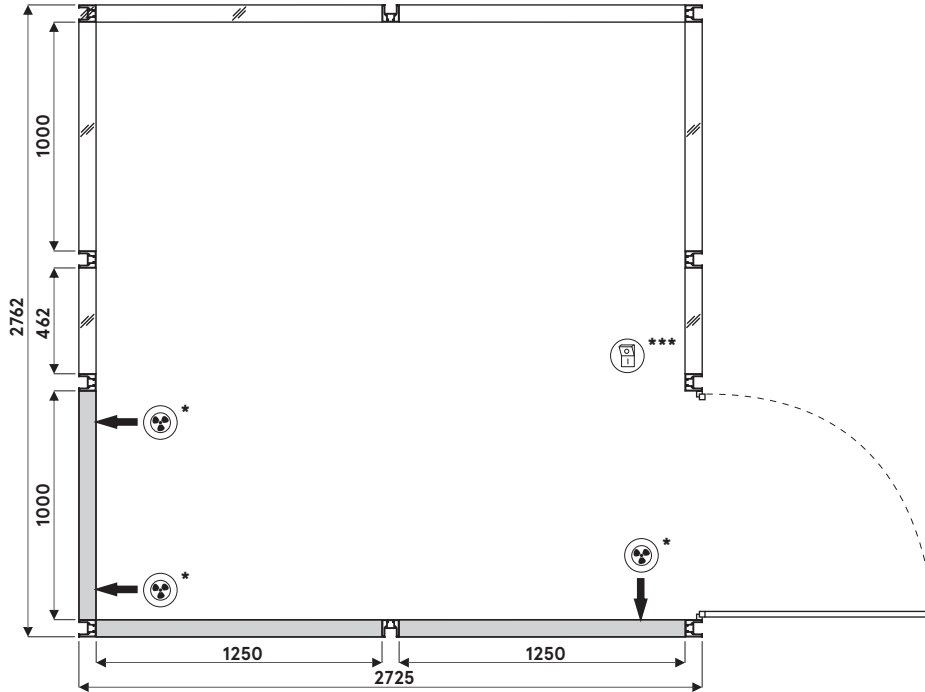

HK05

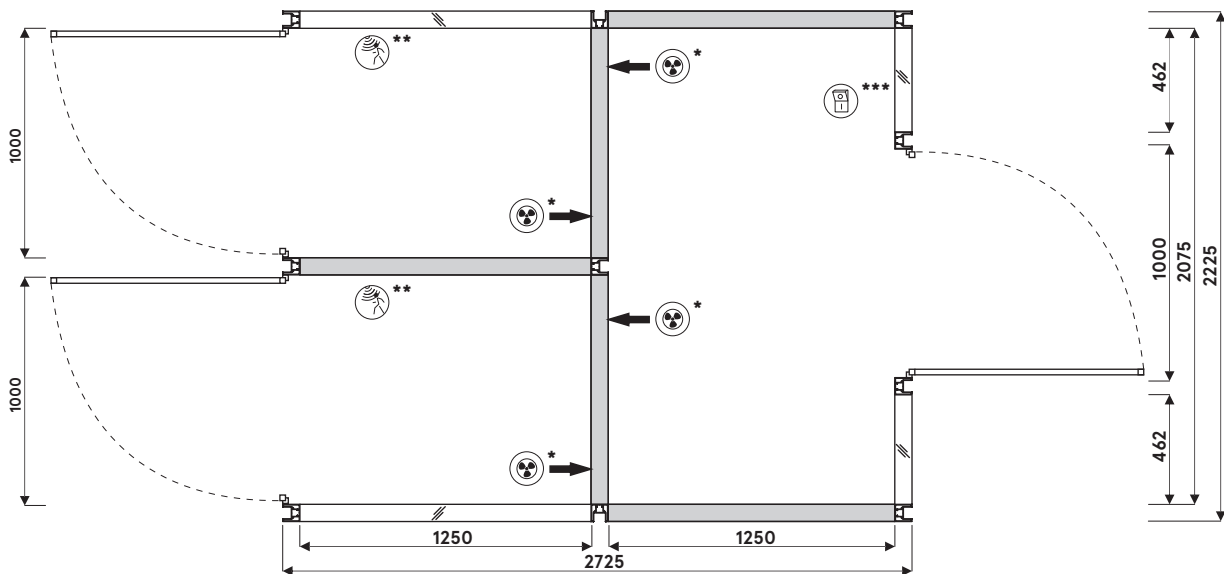

Legend:

- \* fan (located near the floor) - Attention! It is suggested not to block fans to ensure the proper airflow rate
- \*\* motion sensor
- \*\*\* wireless light switch - which can be situated in any place

HK06

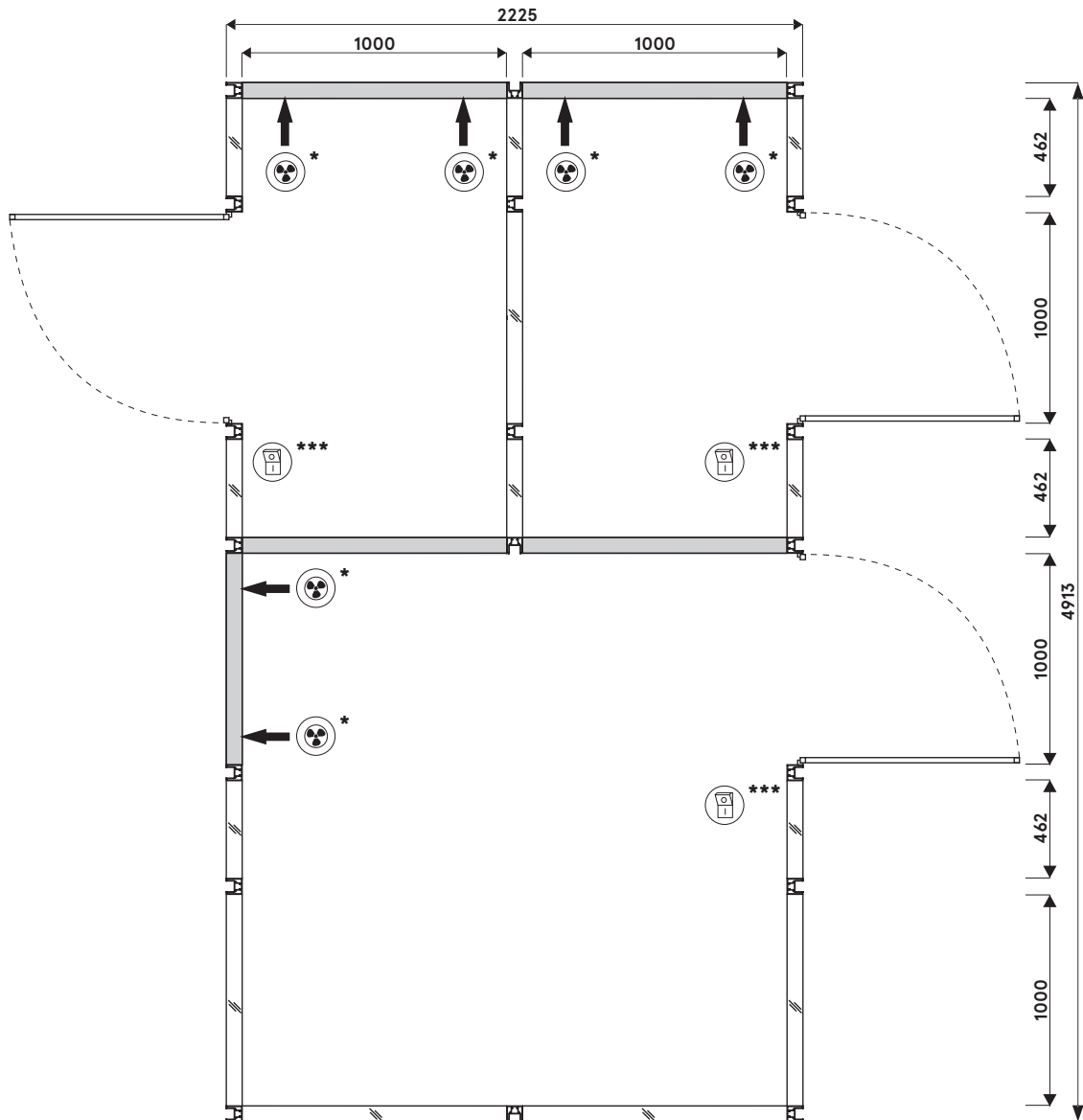

www.mdd.eu

Legend:

- \* fan (located near the floor) - Attention! It is suggested not to block fans to ensure the proper airflow rate
- \*\* motion sensor
- \*\*\* wireless light switch - which can be situated in any place

HK07

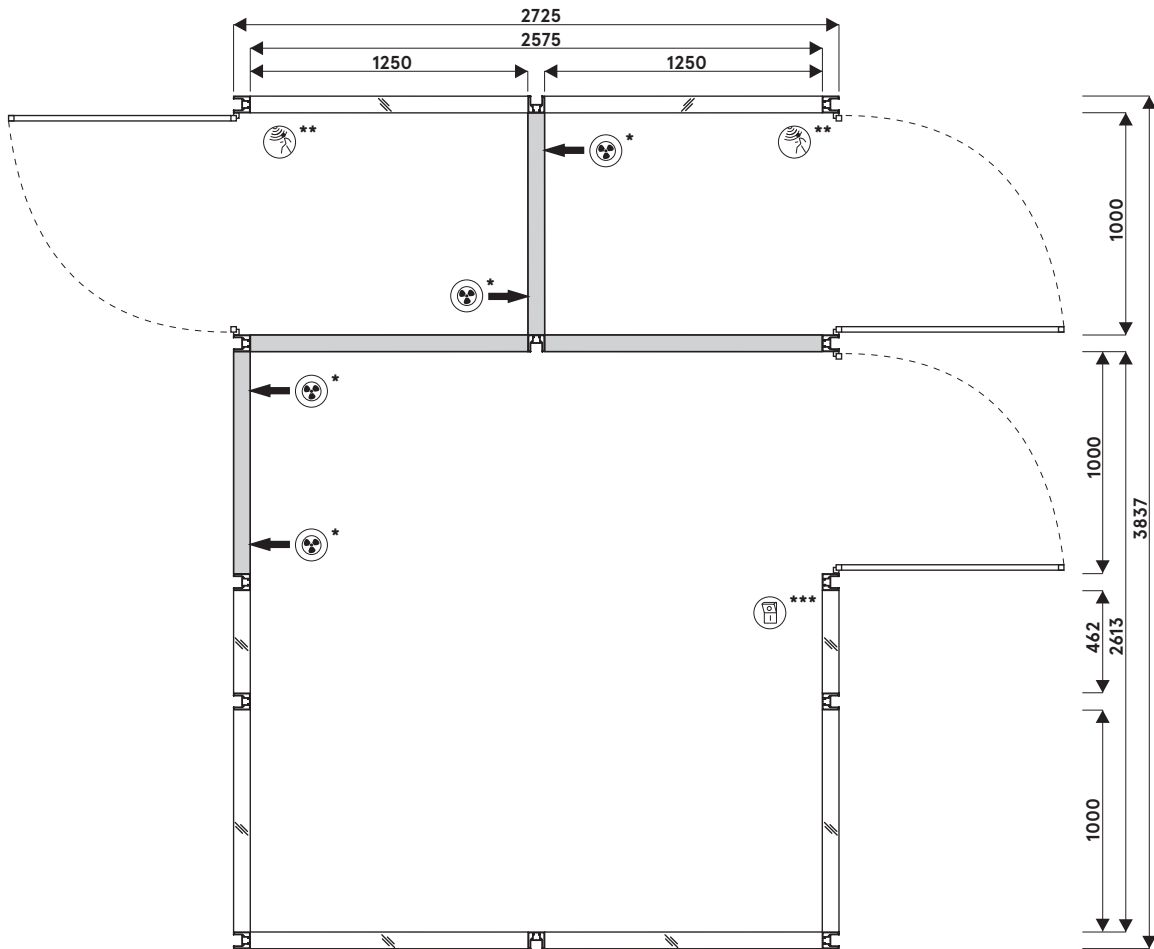

Configuration examples

HK01

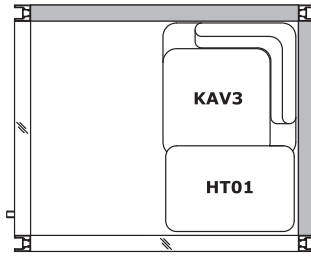
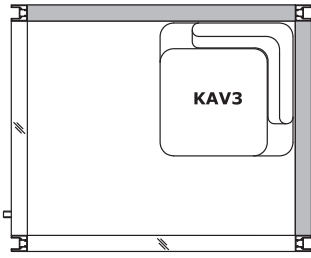

HK021

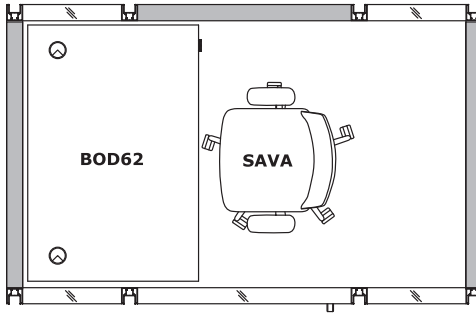
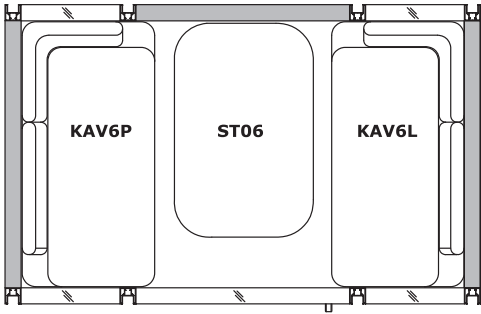

HK03

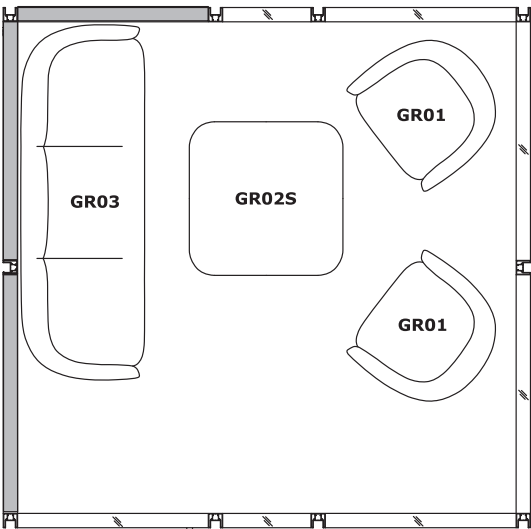
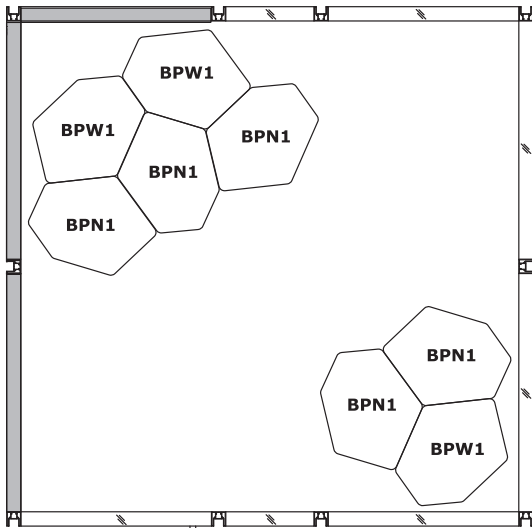
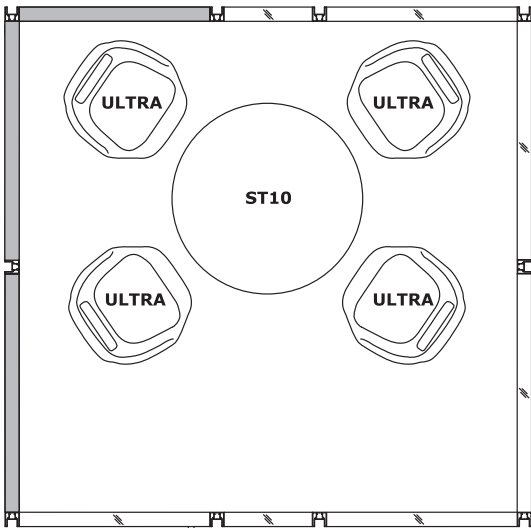

www.mdd.eu



Hako - office booth \*

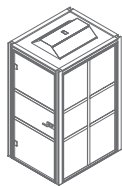

**HK01**  
1400 / 1150 / 2341  
398 kg

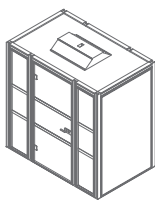

**HK021**  
2225 / 1400 / 2341  
531.18 kg

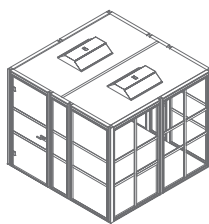

**HK03**  
2762 / 2725 / 2341  
935.3 kg

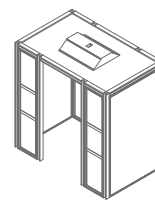

**HK04**  
2225 / 1400 / 2341  
442 kg

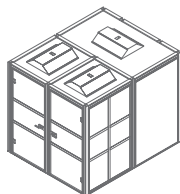

**HK05**  
2725 / 2225 / 2341  
1451.68 kg

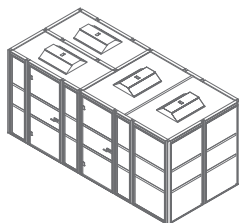

**HK06**  
2225 / 4913 / 2341  
1571 kg

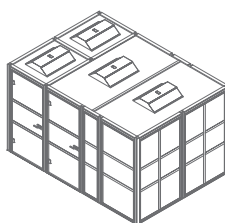

**HK07**  
2725 / 3838 / 2341  
1426.38 kg

Shelf \*

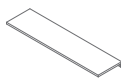

**HK1P**  
980 / 250 / 156  
6 kg

\* dimensions expressed in millimeters: width x depth x height

<b>Hako</b>	Date of preparation 20.12.2019	The data contained in this document is valid in the day of its preparation. Change of the product, as long as it does not affect the basic features of it, does not require consistent updates of the document.	page 9/11
			<b>products</b>

## Office booth – walls outside, inside – fabric Medley – second group



**Technical data:**

**Material** polyester 100%

**Fabric weight** 510 g/lm (16.45 oz/lin.yd.)

**Abrasion resistance rubs** BS EN ISO 12947-2, 75,000 cykli Martindale

**Pilling resistance** scale 1-5, max. 5, EN ISO 12945-2 (4)

**Colour fastness to light** scale 1-8, max. 8, EN ISO 105-B02 (5-7)

**Colour fastness to rubbing** scale 1-5, max. 5, EN ISO 105x12 (wet/dry (4-5/4-5))

**Acoustic test sound absorption** ISO 354

**Flammability** BS EN 1021-1 (cigarette)  
BS 476 Part 7, Class 2  
Class Uno UNI 9174 - UNI 8457  
CA TB 117-2013  
ASTM E 84 Class I

## Office booth – walls outside, inside – fabric Synergy – third price group

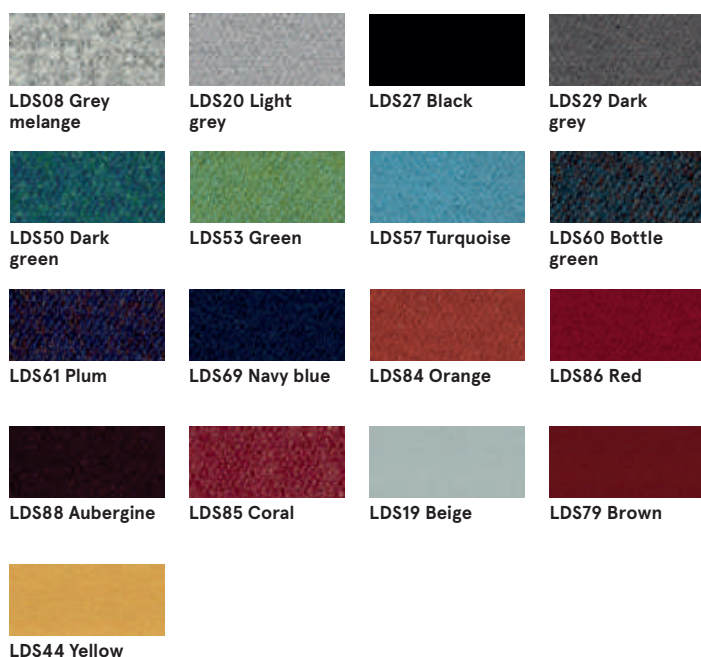

**Technical data:**

**Material** 95% Virgin Wool, 5% Poliamid

**Fabric weight** 400g/m2 ±5% (560 g/lin.m ±5%)

**Abrasion resistance rubs** Independently certified  
≥100,000 Martindale cycles

**Colour fastness to light** 5 (ISO 105 - B02)

**Colour fastness to rubbing** ISO 105 - X12 - wet: 4, dry: 4

**Flammability** EN 1021 - 1 (cigarette),  
EN 1021 - 2 (match),  
BS 7176 Low Hazard,  
UNI 9175 Classe 1 IM,  
ÖNORM B 3825 & A 3800-1

## Fabric Atlas – fourth price group

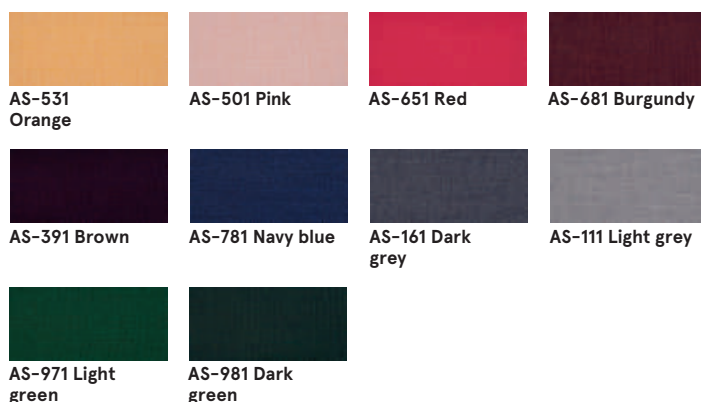

**Technical data:**

**Material** 90% new wool, 10% nylon

**Fabric weight** 286g/m2, 400g/lm

**Abrasion resistance rubs** 100,000 cykli Martindale, EN ISO 12947

**Colour fastness to light** ISO 105 B02: 6-7

**Colour fastness to rubbing** ISO 105-X12:2001, (wet/dry) 4-5/4-5

**Flammability** BS EN 1021-2 Match, BS EN 1021-1 Cigarette,  
BS 5 5852 Crib 5, BS 5852 ignition source 3,  
BS 5852 Part 1, NF D 60 013, UNI 9175 1IM,  
US Cal. Bull. 117-2013

**Fabric Field2 – fourth price group**



**Technical data:**

**Material** 100% Trevira CS  
**Fabric weight** 321g/m2, 450g/lm  
**Abrasion resistance rubs** 100,000 cykli Martindale, EN ISO 12947  
**Colour fastness to light** ISO 105 B02: 5-7  
**Flammability** BS EN 1021-2 Match, BS EN 1021-1 Cigarette, BS 5 5852 Crib 5, DIN 4102 B1 FAR 25.853, UNI 9177 classe 1, US Cal. Bull. 117-2013

**Frame - metal**

