

Farbkombination - Kaiva

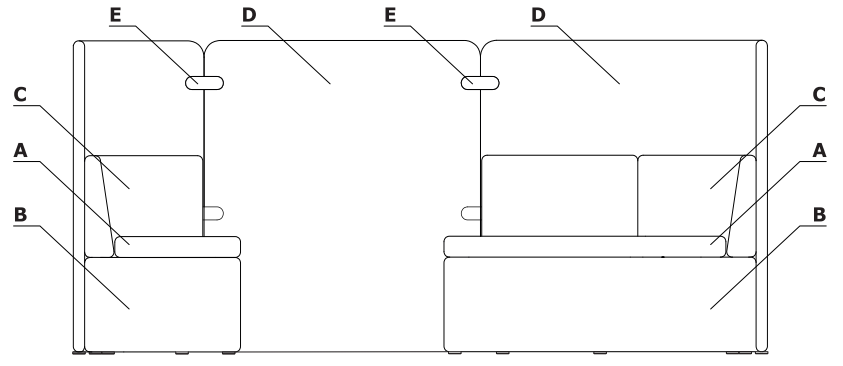

Material	Farbe	KAIVA																
		A - Sitz	B - Kissen	C - Lehne	D - Paneel	E - Verbindungselement												
Stoff	Medley	✓	✓	✓	✓													
	Vita	✓	✓	✓	✓													
	Synergy	III. Gruppe	III. Gruppe	III. Gruppe	III. Gruppe													
	Metal - M154 - anthrazit halbmatt					✓												

Technische Beschreibung

- 1 **Paneel** - Holzrahmen, gepolstert
- 2 **Sitz, Rückenlehne** - Sperrholz bedeckt mit Schaum, Dichte von 55 kg/m³, gepolstert
- 3 **Basis** - Würfel, Holzrahmen, gepolstert
- 4 **Holzrahmen**
- 5 **Verbindungselement** - Metall, pulverbeschichtet, im Satz, 4 Stck./ Paneel

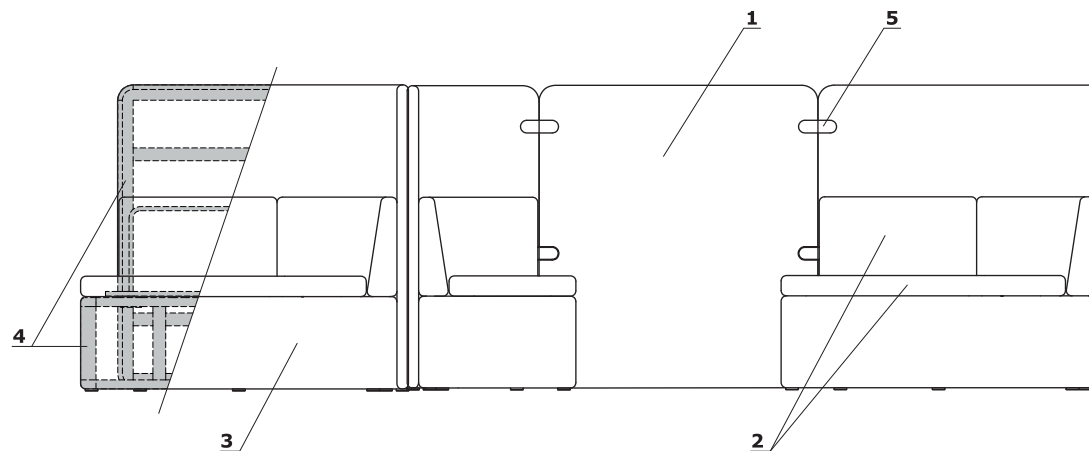





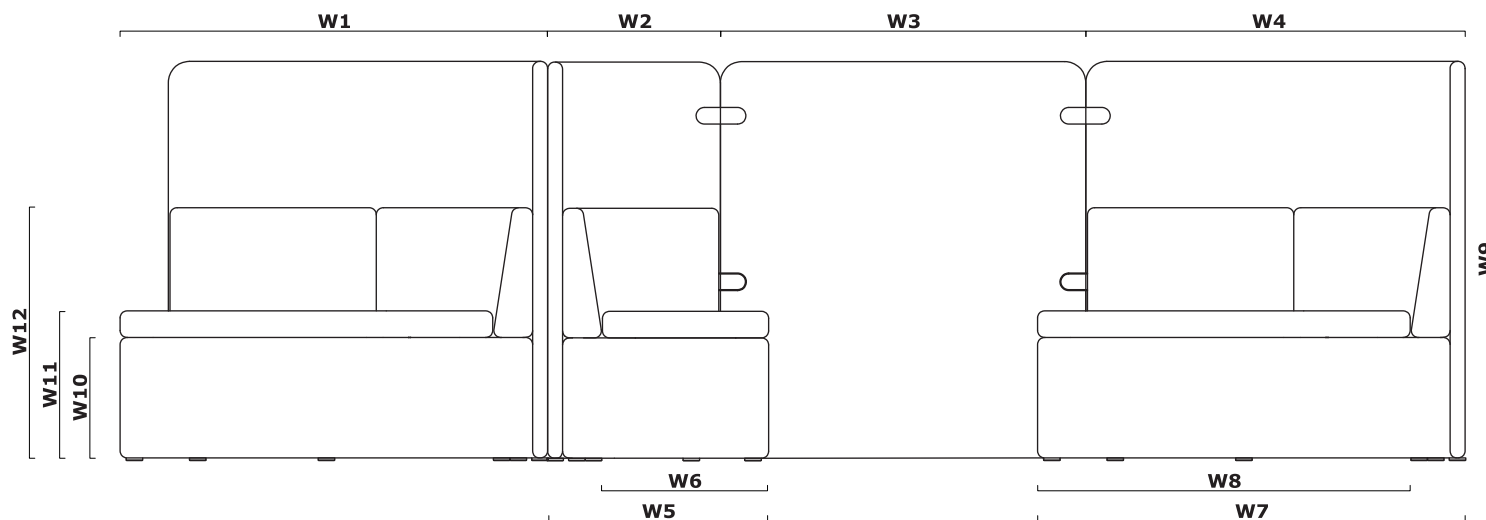





- Tragkraft 120 kg

Abmessungen (mm)



W1 - 1285 | W2 - 580 | W3 - 1100 | W4 - 1245 | W5 - 665 | W6 - 500 | W7 - 1285 | W8 - 1120 | W9 - 1350 | W10 - 370 | W11 - 450 | W12 - 760|

	Symbol	II	III	kg m ³ pcs	Zusätzliche Informationen
		Medley, Vita	Synergy		
	KAV1			30 0,666 1	kleiner Sitz mit hohem Paneel
	KAV2P			30 0,666 1	kleiner Sitz mit rechter Rückenlehne und hohem linkem Paneel
	KAV2L			30 0,666 1	kleiner Sitz mit linker Rückenlehne und hohem rechtem Paneel
	KAV3			25 0,333 1	kleiner Sitz ohne Paneel
	KAV4P			40 1,261 1	großer Sitz mit hohem rechtem Paneel
	KAV4L			40 1,261 1	großer Sitz mit hohem linkem Paneel
	KAV5P			40 1,261 1	großer Sitz mit rechter Rückenlehne und hohem linkem Paneel
	KAV5L			40 1,261 1	großer Sitz mit linker Rückenlehne und hohem rechtem Paneel
	KAV6P			35 0,652 1	großer Sitz ohne Paneel, rechts

	Symbol	II	III	kg m ³ pcs	Zusätzliche Informationen
		Medley, Vita	Synergy		
	KAV6L			35 0,652 1	großer Sitz ohne Paneel, links
	KAV10			10 0,116 1	hohes Paneel