

Colour combination - Kaiva

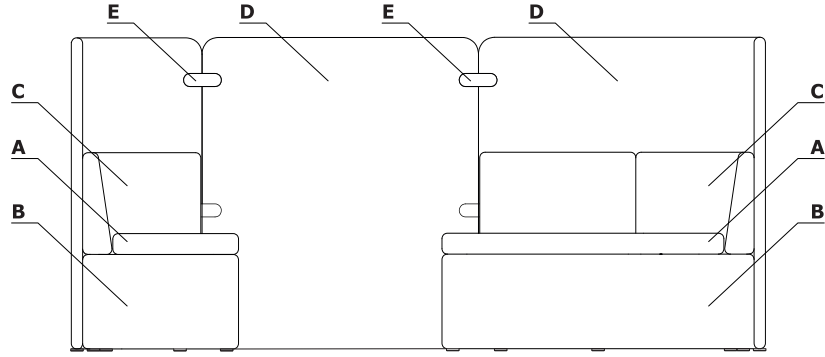

Material	Colour	KAIVA															
		A - Seat	B - Pillow	C - Back	D - Screen	E - Connecting element											
Fabric	Medley	✓	✓	✓	✓												
	Synergy	III group ✓	III group ✓	III group ✓	III group ✓												
	Metal - M154 - anthracite semi-mat					✓											

Technical specification

- 1 Screen** - wooden frame, upholstered
- 2 Seat, backrest** - plywood covered with foam, density of 55 kg/m³, upholstered
- 3 Base** - cube, wooden frame, upholstered
- 4 Wooden frame**
- 5 Connecting element** - powder coated steel ,included, 4 pcs/ screen

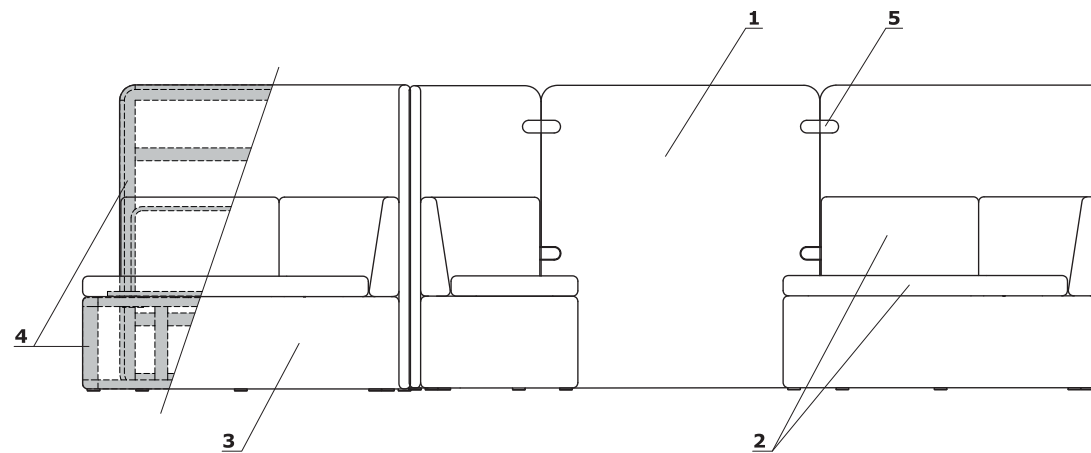





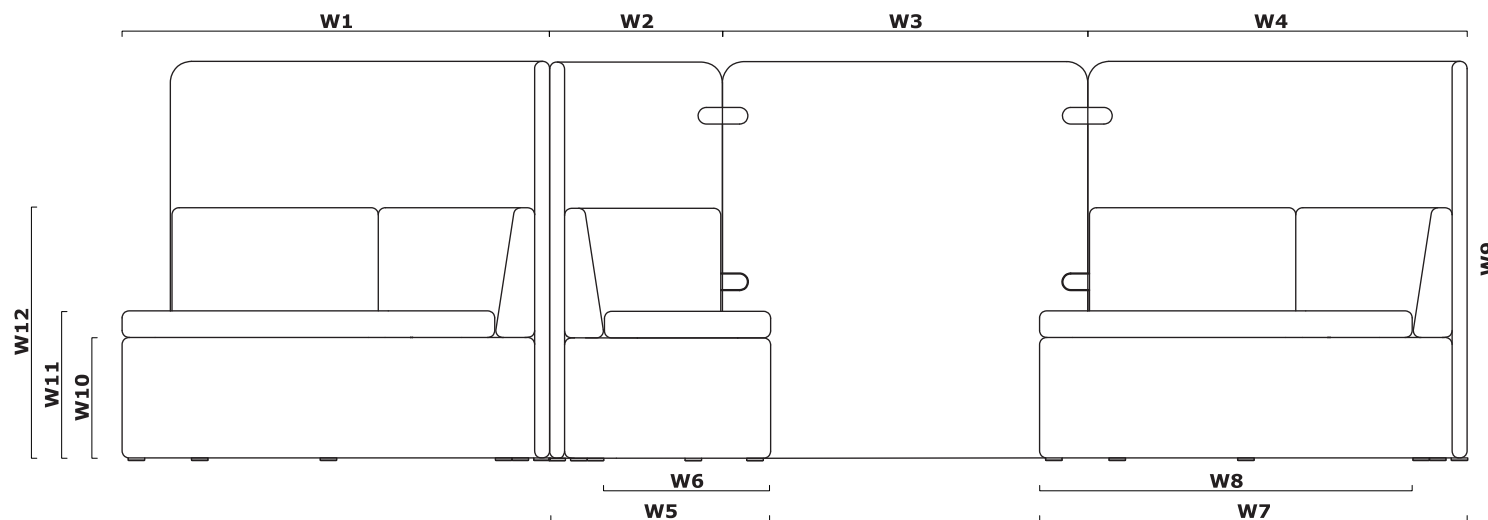





- max. load 120 kg

Dimensions



W1 - 1285 | W2 - 580 | W3 - 110 | W4 - 1245 | W5 - 665 | W6 - 500 | W7 - 1285 | W8 - 1120 | W9 - 1350 | W10 - 370 | W11 - 450 | W12 - 760 |

	Symbol	II	III	kg m3 pcs	Additional information
		Medley	Synergy		
	KAV1			30 0,666 1	small seat with high screen
	KAV2P			30 0,666 1	small seat with right backrest and high left screen
	KAV2L			30 0,666 1	small seat with left backrest and high right screen
	KAV3			25 0,333 1	small seat without screen
	KAV4P			40 1,261 1	large seat with high right screen
	KAV4L			40 1,261 1	large seat with high left screen
	KAV5P			40 1,261 1	large seat with right backrest and high left screen
	KAV5L			40 1,261 1	large seat with left backrest and high right screen
	KAV6P			35 0,652 1	large seat without screen, right

	Symbol	II	III	kg m3 pcs	Additional information
		Medley	Synergy		
	KAV6L			35 0,652 1	large seat without screen, left
	KAV10			10 0,116 1	high screen